

## TEKNISK DATA

# TRIAAIR JUPITER



## JUPITER-3

### 2500/4900 m<sup>3</sup>/h (3700)

TriaAir Jupiter er et fleksibelt, modulopbygget ventilationsanlæg til erhverv, institutioner og større boligbyggerier med høj driftssikkerhed.



HVACCALC V. 2.2.3.77  
28.06.2025

BSK 1/8

TEKNISKE DATA			
Dato	02.07.2025	Rev. dato	07.07.2025
Projekt-ID	8054	Sagsnummer	63924
Projektnavn	Ventilationsenhed komfortanlæg.		
AHU-navn	AHU-3 2500/4900 (3700) - (1 stk.)		
AHU-model	JUPITER 8 X 12 [370 CHE HWC]		



Report to performance data

Report to performance data

ODENSE

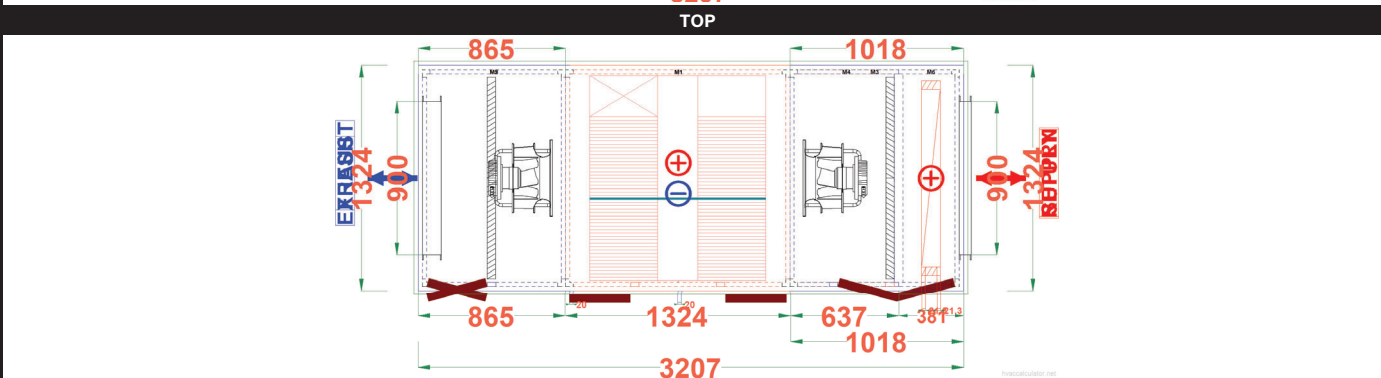
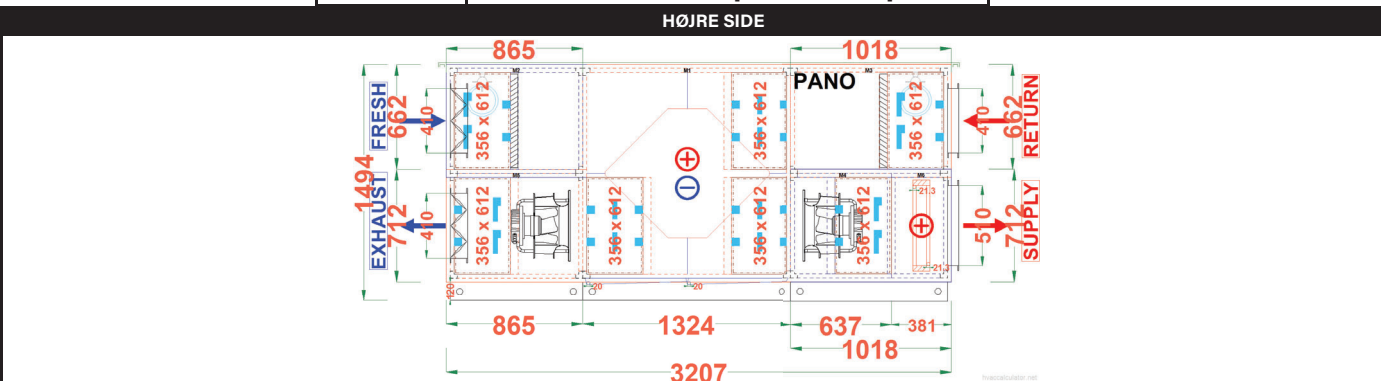

GENERELLE SPECIFIKATIONER

Luftmængde indblæsning	Luftmængde udsugning	Model / Ramme	Mål (mm) (Størrelse + sokkel + spjæld + rør)
3.700 m³/h	3.700 m³/h	JUPITER 25 / 25 stålprofil	B 1.424 x H 1.469 x L 3.337
Lufthastighed	Returlufthastighed	Isoleringsmateriale	Total vægt
1,37 m/s	1,37 m/s	50 mm Rockwool 70 kg/m³	1.186 kg
Kølehastighed	Luftdensitet	Materiale til yderplader	Sokkel
1,94 m/s	1,3478 kg/m³	0,9 mm malet galvaniseret	2 mm sokkel / 120 mm
Designet udendørstemperatur (V-S)	HRS kapacitet / effektivitet (V-S)	Materiale til inderplader	Tag (ydside)
(-12°C/90%)-(26°C/60%/WB:20,3°C % /DP:17,6°C) (ODENSE)	30,1 - 3,8 kW / 75 - 75 %	0,9 mm galvaniseret	Plade
Samlet varmeeffekt			Samlet optaget effekt
19,56 kW			1,84 kW
Specifikt ventilatoreffekt (SFP samlet)	Motoreffekt	Nominelt tryk (Indblæsning)	Nominelt tryk (Udsugning)
684 W/(m³/s)	1,5 kW / 1,5 kW	250 Pa	250 Pa
ErP-overensstemmelse	ErP-kode	fs-Pref (V-S)	
2016	NRVU - BVU	0,98 / 0,92	

LYDEFFEKTNIVEAU (dB)



Frekvens Hz	125	250	500	1000	2000	4000	8000	LwA-tot
Lydstyrke fra luftbåren støj	49,7	53,6	44,1	45,0	41,5	40,8	16,7	51,1 dBA
Lydniveau, Friskluft	61,7	65,9	64,5	68,5	64,3	65,8	59,4	72,5 dBA
Lydniveau, Indblæsning	50,7	50,7	50,7	46,5	37,4	24,4	16,3	51,2 dBA
Lydniveau, Afkast	63,2	67,6	66,3	70,1	65,1	66,5	60,5	73,6 dBA
Lydniveau, Udsugning	50,3	50,1	50,6	46,3	37,2	24,2	16,3	50,6 dBA

MB MEKANISKE EGENSKABSKLASSIFICERINGER

Model	CS Klasse	CAL-klasse -400 Pa (M) -400 Pa (R)	CAL-klasse +700 Pa (M) +400 Pa (R)	FBL-klasse	TT-klasse	TBF-klasse	KABINET AKUSTISK ISOLERING [dB]							
							125 Hz	250 Hz	500 Hz	1000 Hz	2000 Hz	4000 Hz	8000 Hz	
JUPITER	D1 (M)	L1 (M)/L2 (R)	L1 (M)/L3 (R)	F9 (M)	T2 (M)	TB2 (M)	20	21	28	31	29	31	46	

www.bskhavalandirma.com.tr      Kontor tf.: +90 216 669 09 70      Fabrik tf.: +90 216 669 09 70  
 info@bskhavalandirma.com.tr      Kontor fax: +90 216 669 09 72      Fabrik fax: +90 216 669 09 72



	<b>TEKNISKE DATA</b>						
	<b>Dato</b>	02.07.2025	<b>Rev. Dato</b>	07.07.2025			
	<b>Projekt-ID</b>	8054	<b>Sagsnummer</b>	63924			
<b>HVACCALC V.</b>	2.2.3.77 28.06.2025						
<b>BSK</b>	2/8						
	<b>Projektnavn</b>	Ventilationsenhed Komfortsystem.					
	<b>AHU-navn</b>	AHU-3 2500/4900 (3700) - (1 stk.)					
	<b>AHU-model</b>	JUPITER 8 X 12 [370 CHE HWC]					

**TILBEHØR**

Belysning (x2), Observationsglas (x2), Nødstop kontakt (x2), Dørkontakt (x2)

**TILSLUTNING FRISKLUFT**

<b>Tilslutningstype</b>	<b>Styringstype</b>	<b>Tryktab</b>
Gearspjæld	Motor (Tænd/Sluk) (LM230ASR)	0 Pa
<b>Luftmængde</b>	<b>Dimensioner</b>	<b>Lufthastighed</b>
3.700 m <sup>3</sup> /h	B 900 mm x H 410 mm	2,79 m/s

**INDBLÆSNINGSTILSLUTNING**

<b>Tilslutningstype</b>	<b>Styringstype</b>	<b>Tryktab</b>
Flange		0 Pa
<b>Luftmængde</b>	<b>Dimensioner</b>	<b>Lufthastighed</b>
3.700 m <sup>3</sup> /h	B 900 mm x H 510 mm	2,24 m/s

**UDSUGNINGSTILSLUTNING**

<b>Tilslutningstype</b>	<b>Styringstype</b>	<b>Tryktab</b>
Flange		0 Pa
<b>Luftmængde</b>	<b>Dimensioner</b>	<b>Lufthastighed</b>
3.700 m <sup>3</sup> /h	B 900 mm x H 410 mm	2,79 m/s

**AFKASTTILSLUTNING**

<b>Tilslutningstype</b>	<b>Styringstype</b>	<b>Tryktab</b>
Gearspjæld	Motor (Tænd/Sluk) (LM230ASR)	0 Pa
<b>Luftmængde</b>	<b>Dimensioner</b>	<b>Lufthastighed</b>
3.700 m <sup>3</sup> /h	B 900 mm x H 410 mm	2,79 m/s

**FILTER (M3)**

<b>Luftmængde</b>	<b>Kondensbakke</b>	<b>Skuffetype</b>	<b>Hygiejnisk</b>	<b>Ekstra filter</b>	<b>Sektionsvægt</b>
3.700 m <sup>3</sup> /h		Ingen	<input type="checkbox"/>	<input type="checkbox"/>	161 kg
<b>Filertype</b>					
M-6 (ePM10 %50) panel					
<b>Start / Slut / Design tryktab</b>	<b>Lufthastighed</b>	<b>Størrelse/Antal/EC*</b>	<b>Størrelse/Antal/EC*</b>	<b>Størrelse/Antal/EC*</b>	<b>Størrelse/Antal/EC*</b>
46 Pa / 138 Pa / 92 Pa	1,47 m/s	592x592x48/2/A			

\* Filterets energiydelse; helst energiklassificering

\* Rammepakning er anvendt.

**TILBEHØR (M3)**

Belysning, observationsglas

www.bskhavalandirma.com.tr  
info@bskhavalandirma.com.trKontor tlf.: +90 216 669 09 70  
Kontor fax: +90 216 669 09 72Fabrik tlf.: +90 216 669 09 70  
Fabrik fax: +90 216 669 09 72**TSEK**

ErP - COMPLIANT TO EUROPEAN DIRECTIVE VENTILATION UNITS (AHU)



TEKNISKE DATA			
Dato	02.07.2025	Rev. dato	07.07.2025
Projekt ID	8054	Sagsnummer	63924
Projekt navn	Ventilationsenhed Komfortanlæg.		
AHU-navn	AHU-3 2500/4900 (3700) - (1 stk.)		
AHU-model	JUPITER 8 X 12 [370 CHE HWC]		

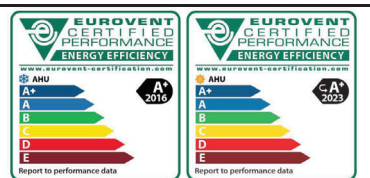

HVACCALC V.:	2.2.3.77 28.06.2025
BSK	3/8

**MODSTRØMSVARMEVEKSLER (M1)**

Model	Hoval-GV-075/P1/1204/BSK240,G2			OACF (*)	1,00	EATR (%)	1,00	(*) Antal	1 x 2	Sektionsvægt	458 kg
Luftstrøm	Friskluft		Afkast		Kapacitet	Vinter		Sommer		3,8 kW	
Luftfastighed	3.700 m³/h		3.700 m³/h			30,1 kW					
Våd	Vinter		Sommer		P.D	Friskluft	Afkast	Friskluft	Afkast		
	Effektivitet	Balance(*)	Effektivitet	Balance(*)		153 Pa	155 Pa	172 Pa	170 Pa		
Tør	Vinter		Sommer		Bypass	Friskluft	Afkast	Friskluft	Afkast		
	76 %	76 %	75 %	75 %		165 Pa	165 Pa	165 Pa	165 Pa		
Energibesparelse	Vinter		Sommer		Luft kondensation	0,6932 l/h		1,8859 l/h		0,0770 l/h	
	74 %	74 %	75 %	75 %		0 Pa		178 Pa		0 Pa	
ErP-effektivitet	73 %		73 %								
ErP-effektivitet	75 %		75 %								

Luft ind/ud	Vinter				Sommer			
	Friskluft		Udsugning		Friskluft		Udsugning	
	Indgang	Udgang	Indgang	Udgang	Indgang	Udgang	Indgang	Udgang
DT	-12 °C	12,3 °C	20 °C	-2,3 °C	26 °C	23 °C	22 °C	25 °C
WT	-12,3 °C	3,3 °C	10 °C	-2,3 °C	20,3 °C	19,4 °C	13,9 °C	15 °C
RH	90 %	14 %	25 %	100 %	60 %	72 %	40 %	33 %

Kondensbakke	Størrelse mm (**)	Bypass spjæld
Rustfrit stål (20 mm (ø)) (Tilslutning: højre) (Tryk: negativt)	1.040-514-246-21-482-815	B 240 mm x H 514 mm

\* Effektivitet ved balanceret luftstrøm  
 \* OACF: Korrektionsfaktor for frisk luft, EATR: Overføringsforhold for udsugningsluft  
 \*\* Længde - Kantlængde - Horisontal kant - Vertikal kant - Bredde - Højde

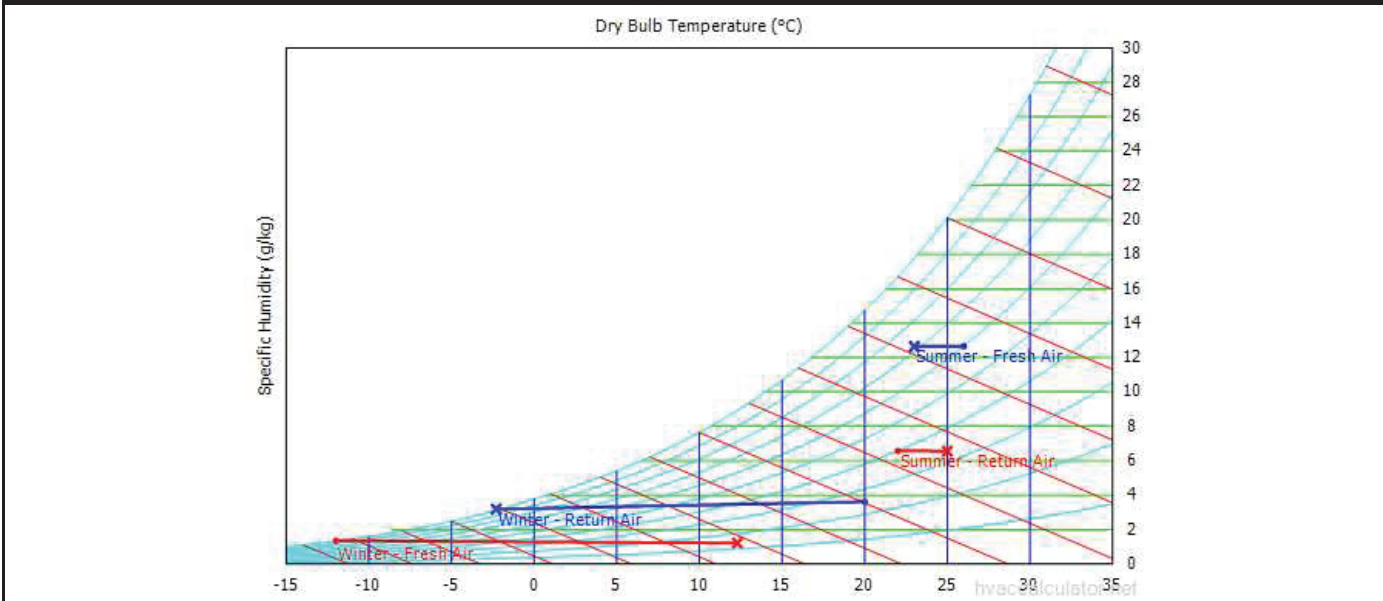

**TILBEHØR (M1)**



www.bskhavalandirma.com.tr	Kontortelefon:	+90 216 669 09 70	Fabriksnummer:	+90 216 669 09 70
info@bskhavalandirma.com.tr	Kontorfax:	+90 216 669 09 72	Fabrikfax:	+90 216 669 09 72





TEKNISKE DATA			
Dato	02.07.2025	Revisionsdato	07.07.2025
Projekt-ID	8054	Sagsnummer	63924
Projekt navn	Komfortventilationsenhed.		
AHU-navn	AHU-3 2500/4900 (3700) - (1 stk.)		
AHU-model	JUPITER 8 X 12 [370 CHE HWC]		

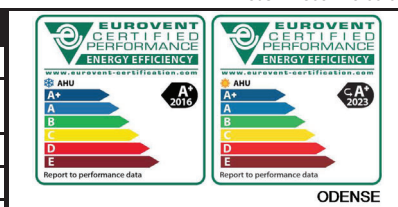

**UDSUGNINGSVENTILATOR (M5)**

Luftmængde	3.700 m³/h	Motor type	EC	Ventilator model	EBM Papst-8300101293-VBH0355CTPMS	Antal	1	Sektionens vægt	186,5 kg
Internt nominelt tryktab	257 Pa	Motor P./Fase/Volt./Frekvens	1,5 kW/3F/400V/50-60V-Hz	Effektmargin	81 %	K-faktor		Isolator	
Nominelt tryktab	250 Pa			Backup ventilator	0	Backup motor	0	Backup inverter	0
Samlet nominelt tryktab	507 Pa								
Samlet tryktab	554 Pa	Systemeffekt	10 Pa						
Samlet / Statisk effektivitet	68,75 / 62,89 %								
Akseleffekt / Optaget effekt	0,83 / 0,9 kW	Optaget effekt med VFD	0,9 kW						
Ventilatorhastighed	2461 o/min (Max. 3100 o/min)								
Lufthastighed for ventilator	9,88 m/s	Luftens densitet	1,2000 kg/m³						
Specifikt ventilatorforbrug (SFP int)	336 W/(m³/s)	Elektrisk strøm / U-styring	1,30 A (Max. 2,35 A) / 7,59 V						

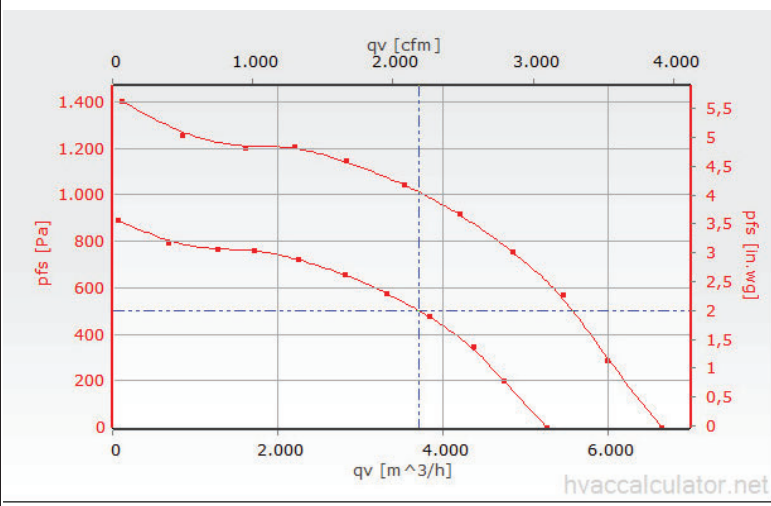

Lydstyrke (dB)										
Hz	63	125	250	500	1000	2000	4000	8000	LwA-tot	
Efter ventilator	67,9	66,5	69,7	69,8	73,8	71,5	70,7	64,4	78,2	dBa
Før ventilator	67,5	65,5	68,6	67,2	67,6	68,0	67,6	61,4	74,2	dBa

\* Ventilatorens systemeffekt er taget med i ydelsen  
 \* Ventilatoren er beregnet til våde forhold

**TILBEHØR (M5)**

Nødstop kontakt, Dørkontakt 

FILTER (M2)							
Luftmængde	3.700 m³/h	Kondensbakke	Skubtype	Hygiensk	Ekstra filter	Sektionsvægt	154,1 kg
Filter type	F-7 (ePM1 %55) panel						
Start / Slut / Design tryktab	57 Pa / 157 Pa / 107 Pa	Lufthastighed	1,47 m/s	Størrelse/Antal/EC*	592x592x48/2/A+	Størrelse/Antal/EC*	

\* Filterets energiydelse; helst energiklassificering  
 \* Rammetætning anvendt.

**TILBEHØR (M2)**

Belysning, Observationsglas 

www.bskhavalandirma.com.tr      Kontor tlf.: +90 216 669 09 70      Fabriks tlf.: +90 216 669 09 70  
 info@bskhavalandirma.com.tr      Kontor fax: +90 216 669 09 72      Fabriks fax: +90 216 669 09 72





TEKNISKE DATA			
Dato	02.07.2025	Rev. dato	07.07.2025
Projekt-ID	8054	Sagsnummer	63924
Projektnavn	Ventilationsenhed Komfortanlæg.		
AHU Navn	AHU-3 2500/4900 (3700) - (1 stk.)		
AHU Model	JUPITER 8 X 12 [370 CHE HWC]		

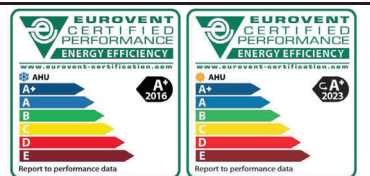

ODENSE

**INDBLÆSNINGSVENTILATOR (M4)**

Luftmængde	3.700 m³/t	Motorstype	EC	Ventilatormodel	EBM Papst-8300101293-VBH0355CTPMS	Antal	1	Sektionens vægt	124,6 kg
Internt nominelt tryktab	284 Pa	Motor P./Fase/Volt./Frekv.	1,5 kW/3F/400V/50-60V-Hz	Effektmargin	74 %	K-faktor		Isolator	
Nominelt tryktab	250 Pa			Backup-ventilator	0	Backup-motor	0	Backup-inverter	0
Samlet nominelt tryktab	534 Pa								
Samlet tryktab	581 Pa	Systemeffekt	10 Pa						
Total / Statisk virkningsgrad	69,39 / 63,75 %								
Akseleffekt / Optaget effekt	0,86 / 0,94 kW	Optaget effekt med VFD	0,94 kW						
Ventilatorhastighed	2498 rpm (Maks. 3100 rpm)								
Lufthastighed for ventilator	9,88 m/s	Luftens tæthed	1,2000 kg/m³						
Specifik ventilatoreffekt (SFP int)	348 W/(m³/s)	Elektrisk strøm / U-kontrol	1,35 A (Maks. 2,35 A) / 7,71 V						

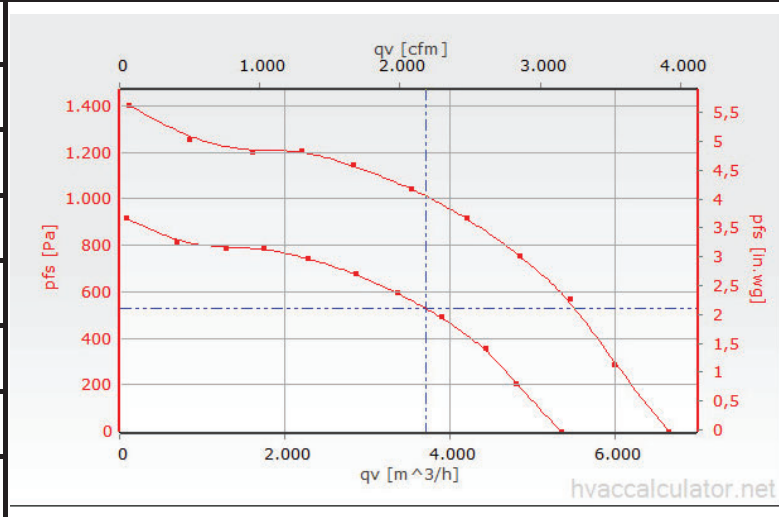

Hz	Lydstyrkeniveau (dB)									LwA-tot	
	63	125	250	500	1000	2000	4000	8000			
Efter ventilator	68,3	66,9	69,9	69,9	74,1	71,7	71,0	64,2	78,4	dB	
Før ventilator	68,1	66,0	69,3	67,3	67,8	68,3	67,9	61,2	74,4	dB	

\* Ventilatorens systemeffekt er inkluderet i ventilatorens ydeevne

\* Ventilatoren er beregnet til fugtige forhold

**TILBEHØR (M4)**

Nødstop kontakt, Dørkontakt



www.bskhavalandirma.com.tr	Kontortelefon:	+90 216 669 09 70	Fabriktelefon:	+90 216 669 09 70
info@bskhavalandirma.com.tr	Kontorfax:	+90 216 669 09 72	Fabrikfax:	+90 216 669 09 72



ErP - COMPLIANT TO EUROPEAN DIRECTIVE VENTILATION UNITS (AHU)



TEKNISKE DATA			
Dato	02.07.2025	Revisionsdato	07.07.2025
Projekt-ID	8054	Sagsnummer	63924
Projektnavn	Ventilationsenhed Komfortsystem.		
AHU-navn	AHU-3 2500/4900 (3700) - (1 stk)		
AHU-model	JUPITER 8 x 12 [370 CHE HWC]		



**VARMEFLADE (M6)**

Luftmængde	Kapacitet	Nødvendig kapacitet	Front-hastighed	Pitch	Antal	Sektionsvægt						
3.700 m³/h	19,56 kW		1,94 m/s	2,5	1	102,3 kg						
Varmekode	32 x 28 12 16T 1R 1044A 2.5P 2NC		Rørmateriale	Lamelmateriale	Funktion							
			Kobber	Aluminium	Opvarmning							
Dråbefjerner / Trykfald	Kondensbakke / Hmin U-fælde		Rørvægttykkelse	Lamelletykkelse	Blandingsforhold							
			0,35 mm	0,1 mm	0 %							
Væsketype	Temperatur	Størrelse (B x H x L) mm		Forbindelsesmateriale	Rammemateriale							
VAND	80/60 °C	1.044 x 508 x 27,5		Stål	Galvaniseret stål							
Luftindtag tørtemperatur	Luftudgang tørtemperatur											
12,3 °C	27,6 °C											
Luftindtag vådtemperatur	Luftudgang vådtemperatur											
3,3 °C	10,8 °C											
Luftindtag relativ luftfugtighed	Luftudgang relativ luftfugtighed											
14 %	5 %											
Luftindtag-udgang entalpi	Væskestrøm / Volumenstrøm											
15,44 - 30,89 kJ/kg	884 kg/h / 910 dm³/h											
Lufttryktab	Væsketryktab / Væskehastighed											
11 Pa	21,94 kPa / 1,16 m/s											
Varme overfladeareal	Rørets indre volumen	<table border="1"> <tr> <td>Luftkondensation</td> <td>Hygiejnisk</td> <td>Blygold</td> </tr> <tr> <td>0,0000 l/h</td> <td><input type="checkbox"/></td> <td><input type="checkbox"/></td> </tr> </table>					Luftkondensation	Hygiejnisk	Blygold	0,0000 l/h	<input type="checkbox"/>	<input type="checkbox"/>
Luftkondensation	Hygiejnisk	Blygold										
0,0000 l/h	<input type="checkbox"/>	<input type="checkbox"/>										
10,79 m²	2,20 L											
Fordeler / Antal forbindelser	Forbindelsesretning											
1 / 1	Højre											
Størrelse på forbindelser												
21,3 / 21,3 mm (1/2" DN15 / 1/2" DN15)												
Bypass-spjæld												

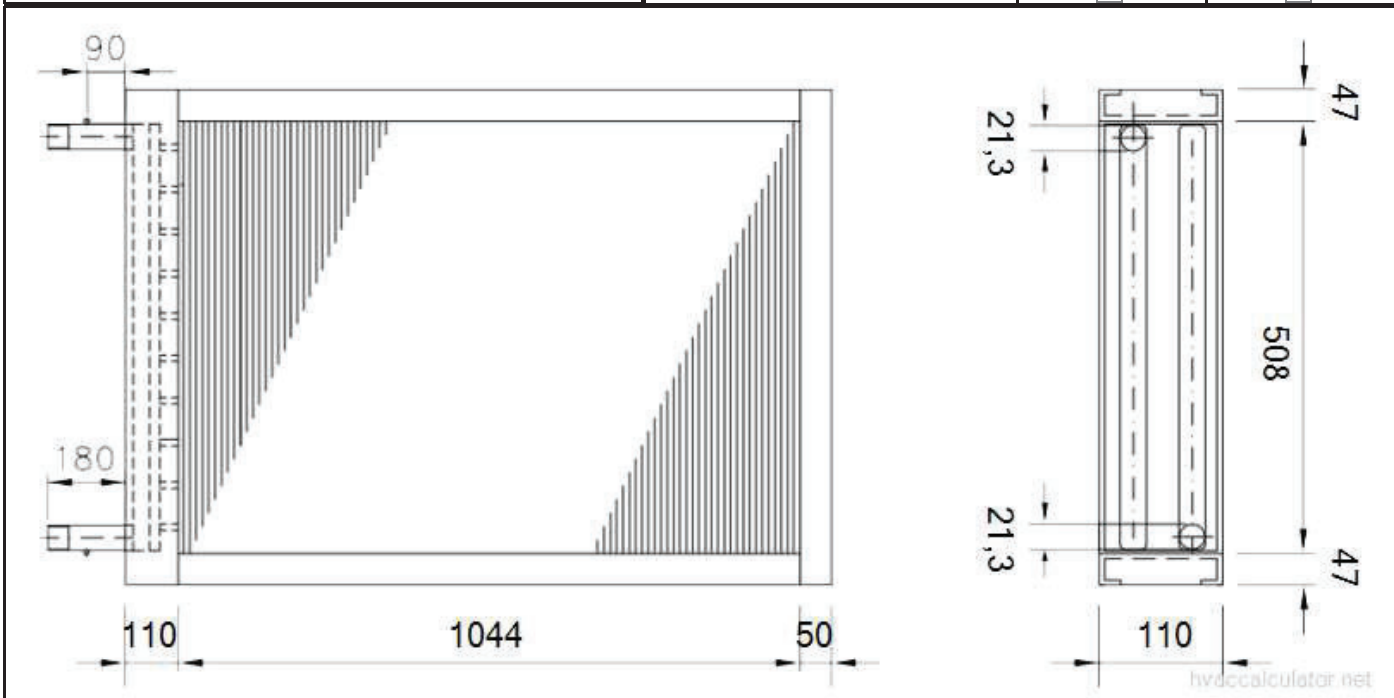

www.bskhavalandirma.com.tr      KONTOR tlf.: +90 216 669 09 70      Fabrik tlf.: +90 216 669 09 70  
 info@bskhavalandirma.com.tr      KONTOR fax: +90 216 669 09 72      Fabrik fax: +90 216 669 09 72





HVACCALC V. 2.2.3.77  
28.06.2025

BSK 7/8

TEKNISKE DATA			
Dato	02.07.2025	Rev. dato	07.07.2025
Projekt-ID	8054	Sagsnummer	63924
Projekt navn	Ventilationsenhed Komfortanlæg.		
AHU-navn	AHU-3 2500/4900 (3700) - (1 stk.)		
AHU-model	JUPITER 8 X 12 [370 CHE HWC]		



Report to performance data

ODENSE

TILBEHØR (M6)



PSYKROMETRISK DIAGRAM

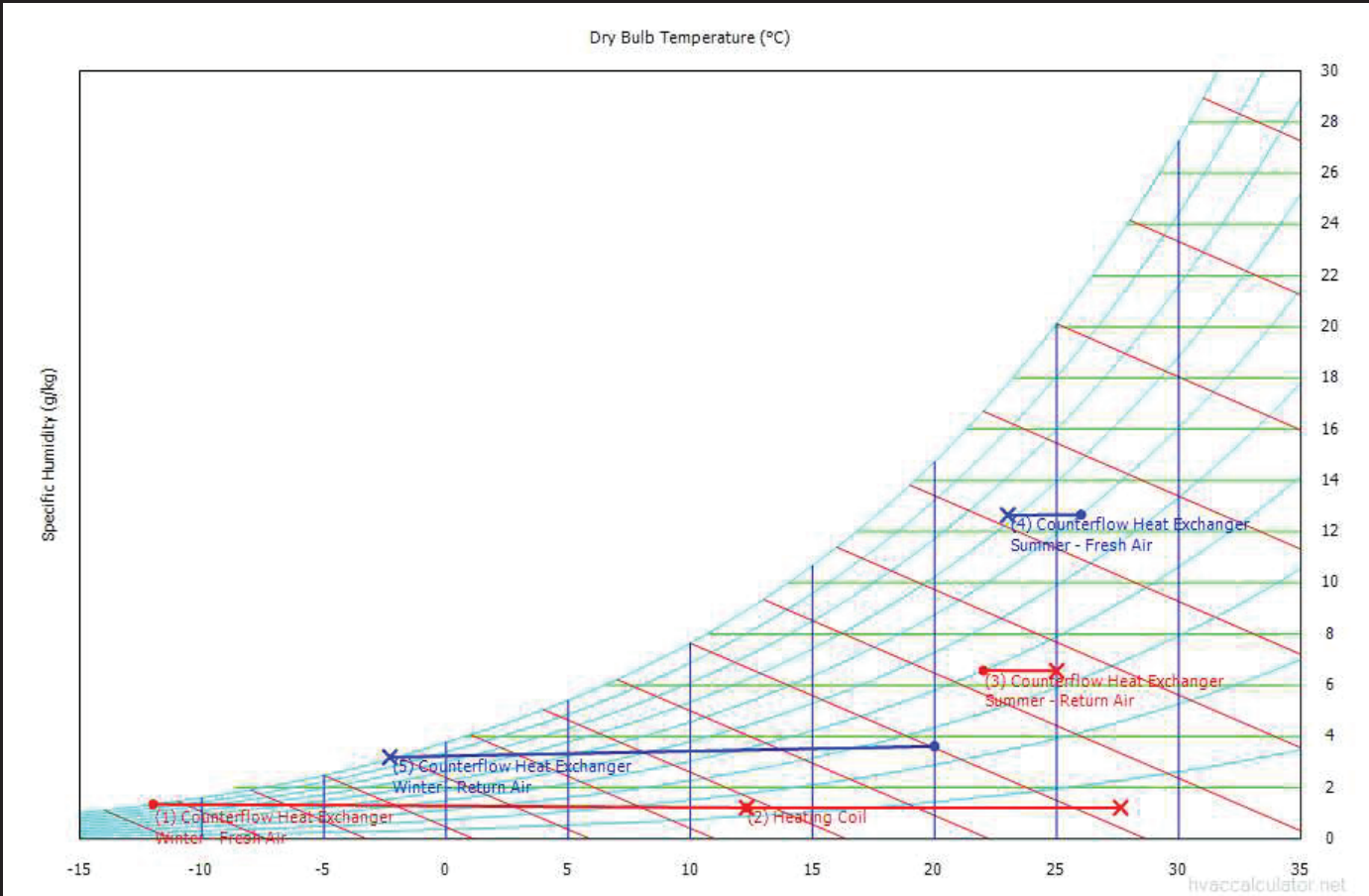

Tekst	Temperatur (Indtag)	Relativ luftfugtighed (Indtag)	Absolute luftfugtighed (Indtag)	Temperatur (Udgang)	Relativ luftfugtighed (Udgang)	Absolute luftfugtighed (Udgang)
(1) Modstrømsvarmeveksler - Vinter - Frisk luft	-12 °C	90 %	1,36 g/kg	12,3 °C	14 %	1,22 g/kg
(2) Varmeflade	12,3 °C	14 %	1,22 g/kg	27,6 °C	5 %	1,22 g/kg
(3) Modstrømsvarmeveksler - Sommer - Afkast	22 °C	40 %	6,58 g/kg	25 °C	33 %	6,56 g/kg
(4) Modstrømsvarmeveksler - Sommer - Frisk luft	26 °C	60 %	12,66 g/kg	23 °C	72 %	12,65 g/kg
(5) Modstrøms varmeveksler - vinter - Afkast	20 °C	25 %	3,62 g/kg	-2,3 °C	100 %	3,19 g/kg

www.bskhavalandirma.com.tr      Kontor tlf.: +90 216 669 09 70      Fabrik tlf.: +90 216 669 09 70  
 info@bskhavalandirma.com.tr      Kontor fax: +90 216 669 09 72      Fabrik fax: +90 216 669 09 72



ErP - COMPLIANT TO EUROPEAN DIRECTIVE VENTILATION UNITS (AHU)



## TEKNISKE DATA

Dato	02.07.2025	Rev. Dato	07.07.2025
Projekt-ID	8054	Sagsnummer	63924
Projekt Navn	Ventilationsenhed Komfortanlæg.		
AHU Navn	AHU-3 2500/4900 (3700) - (1 stk)		
AHU Model	JUPITER 8 X 12 [370 CHE HWC]		

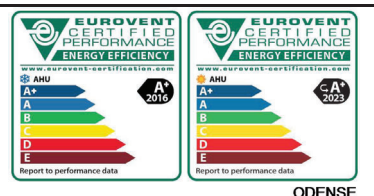

ODENSE



## Ecodesign tabel

		Værdi		2016	2018
	Produkt	JUPITER 25			
	Erp	2016			
A	Producent	BSK Ventilationsudstyr A/S			
B	Modelbetegnelse	JUPITER 8 X 12 [370 CHE HWC]			
C	ErP-kode	NRVU - BVU			
D	Drivtype	Direkte drevet EC-motor, hastighedsstyret	Direkte drevet EC-motor, hastighedsstyret	Påkrævet	Påkrævet
E	Type af veksler	Modstrøm			
	By-pass spjæld	Indeholder		Påkrævet	Påkrævet
F	Temperaturvirkningsgrad for veksler	74,76 %		>= 67 %	>= 73 %
G	Referencevolumestrøm	1,03 m <sup>3</sup> /s	1,03 m <sup>3</sup> /s		
H	Elektriske effektoptag	0,94 kW	0,9 kW		
I	SFPint	348 W/(m <sup>3</sup> /s)	336 W/(m <sup>3</sup> /s)	<= 1279	<= 999
J	Lufthastighed	1,37 m/s	1,37 m/s		
K	Nominelt eksternt tryk Δps, ext	250 Pa	250 Pa		
L	Internt tryktab Δps, int	284 Pa	257 Pa		
M	Addition tryktab Δps, Add	47 Pa	47 Pa		
N	Statisk virkningsgrad ventilator EC327/2011	63,75 %	62,89 %		
O	Maksimalt intern lækage	1,00 %			
P	Energiklassificering filter	A+	A		
Q	Beskrivelse af visuelle filteralarm	Indkluderet	Indkluderet		Påkrævet
R	Lydeffektniveauet (Lwa)	51,1 dBA			
S	Instruktionsadresse på internettet	www.bskhavalandirma.com.tr			

www.bskhavalandirma.com.tr  
info@bskhavalandirma.com.tr

Kontor tlf.: +90 216 669 09 70  
Kontor fax: +90 216 669 09 72

Fabrik tlf.: +90 216 669 09 70  
Fabrik fax: +90 216 669 09 72



TSEK



ErP - COMPLIANT TO EUROPEAN DIRECTIVE VENTILATION UNITS (AHU)