

Rico Series

Product Fact Sheet



FERM
LIVING

Rico Chair - Fixed Base

The Rico Series welcomes curves and volumes into a classic design defined by soft lines and an embracing expression. Featuring four elegant tubular steel legs as the base, the Rico Chair presents a light and refined addition to the Rico family. With its slim and approachable design, it will fit in almost everywhere - whether this is in a small kitchen nook or in a more formal setting.

Customisation Options

Design by Ferm Living

Fabric qualities

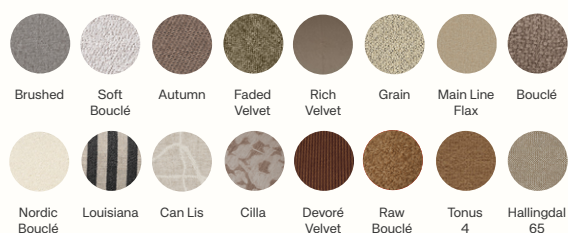

To see the specifications of each fabric and available colour assortment please go to the [Fabric and Leather Overview](#)



Rico Chair
Fixed Base - Black Frame

Information

Manufactured in Lithuania

Dimensions

Height: 80 cm / 34.5 in
Width: 53 cm / 20.9 in
Depth: 50 cm / 19.7 in
Seat height: 48 cm / 18.9 in
Seat depth: 40 cm / 15.7 in
Weight: 6.3 kg / 13.9 lb

Materials and construction Backrest: Moulded foam with inner steel structure. Seat: Moulded foam with inner wooden structure. Frame: Power coated steel or polished aluminium. Glides: Plastic glides. FSC™ Mix-certified wood
Care Please see fermliving.com for care and [maintenance instructions](#)

Packsize 1

Attention This seating is tested to meet relevant strength and durability standards. Tests are based on a person's weight of 110 kg / 242 lb
Test EN 16139:2013. Furniture - Strength, durability, stability and safety. Requirements for non-domestic seating
Foam fire rating CAL117-2013 - pass. BS 5852 Crib5 - on request

Measurements

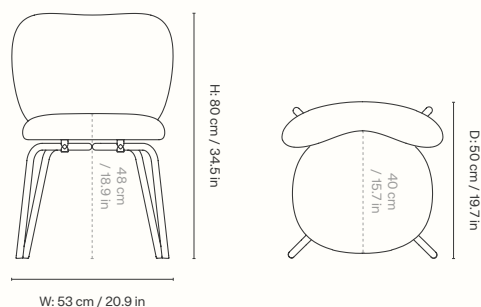

Rico Chair - Swivel Base

The Rico Series welcomes curves and volumes into a classic design defined by soft lines and an embracing expression. Guided by an ever-present sense of contrast, the Rico Chair with Swivel juxtafposes the refinement of chrome against the timeless yet comfortable warmth of soft upholstery. This versatile chair features a robust swivel base, enabling a full 360-degree rotation. Its subtly understated backrest enhances the minimalist aesthetic, providing a refined and cosy feel.

Customisation Options

Design by Ferm Living

Fabric qualities

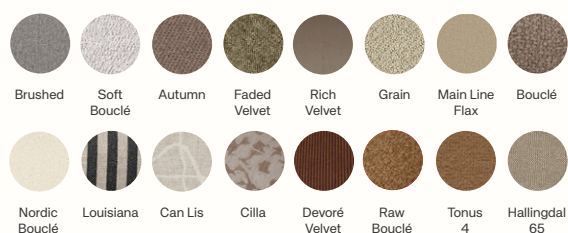

To see the specifications of each fabric and available colour assortment please go to the [Fabric and Leather Overview](#)



Rico Chair
Swivel Base

Information

Manufactured in Lithuania

Dimensions

Height: 80 cm / 31.5 in

Width: 67 cm / 26.4 in

Depth: 67 cm / 26.4 in

Seat height: 48 cm / 18.9 in

Seat depth: 40 cm / 15.7 in

Weight: 8.5 kg / 18.7 lb

Materials and construction Backrest: Moulded foam with inner steel structure.

Seat: Moulded foam with inner wooden structure. Frame: Power coated steel

or polished aluminium. Glides: Plastic glides. FSC™ Mix-certified wood

Care Please see fermliving.com for care and [maintenance instructions](#)

Packsize 1

Attention This seating is tested to meet relevant strength and durability

standards. Tests are based on a person's weight of 110 kg / 242 lb

Test EN 16139:2013. Furniture - Strength, durability, stability and safety.

Requirements for non-domestic seating

Foam fire rating CAL117-2013 - pass. BS 5852 Crib5 - on request

Measurements

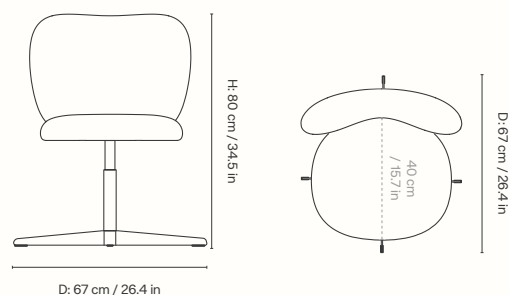

Rico Chair with Castors

The Rico Series welcomes curves and volumes into a classic design defined by soft lines and an embracing expression. Guided by an ever-present sense of contrast, the Rico Chair with Castors juxtaposes the refinement of chrome against the timeless yet comfortable warmth of soft upholstery. This versatile chair features castor wheels for easy mobility and an integrated pump for effortless adjustability. Its subtly understated backrest enhances the minimalist aesthetic, providing a refined and cosy feel.

Customisation Options

Design by Ferm Living

Fabric qualities

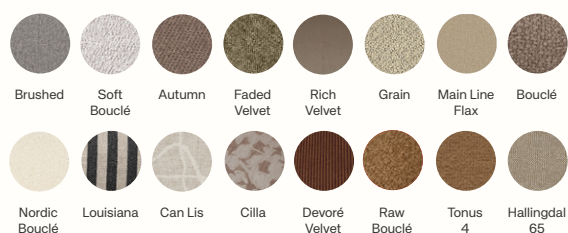

To see the specifications of each fabric and available colour assortment please go to the [Fabric and Leather Overview](#)



Rico Chair
with Castors

Information

Manufactured in Lithuania

Dimensions

Height: 76 - 87.5 cm / 29.9 - 34.3 in

Width: 74 cm / 29.1 in

Depth: 74 cm / 29.1 in

Seat height: 44 - 55.5 cm / 17.3 - 21.9 in

Seat depth: 40 cm / 15.7 in

Weight: 8.5 kg / 18.7 lb

Materials and construction Backrest: Moulded foam with inner steel structure. Seat: Moulded foam with inner wooden structure. Frame: Polished aluminium. FSC™ Mix-certified wood

Care Please see fermliving.com for care and [maintenance instructions](#)

Packsize 1

Attention This seating is tested to meet relevant strength and durability standards. Tests are based on a person's weight of 110 kg / 242 lb

Test EN 16139:2013. Furniture - Strength, durability, stability and safety.

Requirements for non-domestic seating

Foam fire rating CAL117-2013 - pass. BS 5852 Crib5 - on request

Measurements

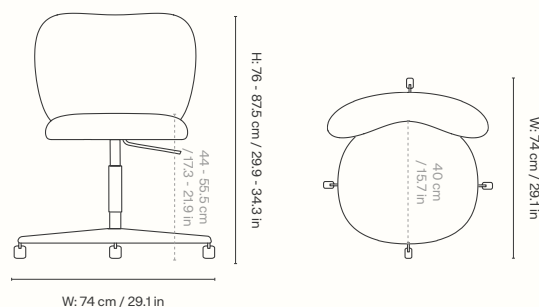

Rico Dining Chair - Fixed Base

The Rico Series welcomes curves and volumes into a classic design defined by soft lines and an embracing expression. Featuring four elegant tubular steel legs as the base, the Rico Dining Chair presents a refined addition to the Rico family. Place it around the dining table and offer your guests a comfortable, inviting seat during long dinner parties, or use it as a desk chair in your own home or at the office.

Customisation Options

Design by Ferm Living

Fabric qualities

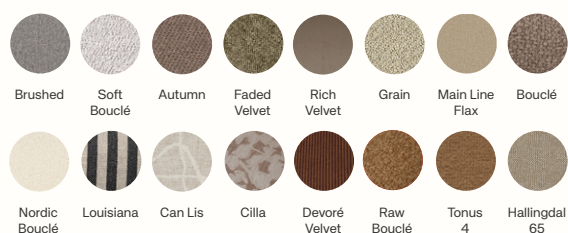

Frame options for fixed base



Cashmere Black

To see the specifications of each fabric and available colour assortment please go to the [Fabric and Leather Overview](#)



Rico Dining Chair
Fixed base - Cashmere Frame

Rico Dining Chair
Fixed base - Black Frame

Information

Manufactured in Italy

Dimensions

Height: 80 cm / 31.5 in
Width: 62.7 cm / 24.7 in
Depth: 55.3 cm / 21.8 in
Seat height: 48 cm / 18.9 in
Seat depth: 44 cm / 17.3 in
Weight: 11.1 kg / 24.5 lb

Materials and construction Backrest: Moulded foam with inner steel structure
Seat: Moulded foam with inner wooden structure. Frame: Powder coated steel or polished aluminium. Glides: Plastic glides. FSC™ Mix-certified wood
Care Please see fermliving.com for care and [maintenance instructions](#)

Packsizes

Attention This seating is tested to meet relevant strength and durability standards. Tests are based on a person's weight of 110 kg / 242 lb
Test EN 16139:2013. Furniture - Strength, durability, stability and safety. Requirements for non-domestic seating
Foam fire rating CAL117-2013 - pass. BS 5852 Crib5 - on request

Measurements

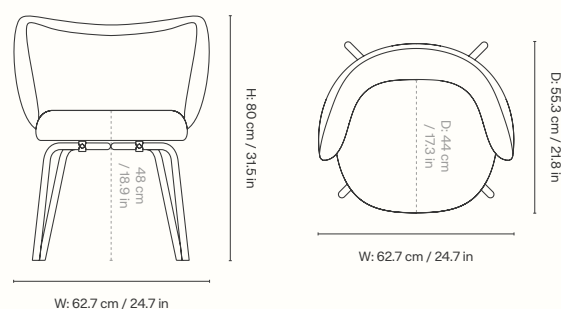

Rico Dining Chair - Swivel Base

The Rico Series welcomes curves and volumes into a classic design defined by soft lines and an embracing expression. Featuring a functional swivel as the base, the Rico Dining Chair presents a refined addition to the Rico family. Place it around the dining table and offer your guests a comfortable, inviting seat during long dinner parties, or use it as a desk chair in your own home or at the office.

Customisation Options

Design by Ferm Living

Fabric qualities

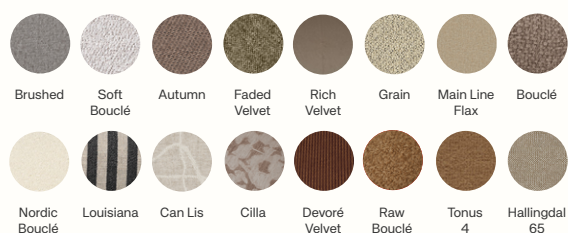

To see the specifications of each fabric and available colour assortment please go to the [Fabric and Leather Overview](#)



Rico Dining Chair
Swivel base

Information

Manufactured in Italy

Dimensions

Height: 80 cm / 31.5 in
 Width: 69 cm / 27.2 in
 Depth: 69 cm / 27.2 in
 Seat height: 48 cm / 18.9 in
 Seat depth: 44 cm / 17.3 in
 Weight: 1.1 kg / 24.5 lb

Materials and construction Backrest: Moulded foam with inner steel structure.
 Seat: Moulded foam with inner wooden structure. Frame: Polished aluminium.
 FSC™ Mix-certified wood

Care Please see fermliving.com for care and [maintenance instructions](#)

Packsize 1

Attention This seating is tested to meet relevant strength and durability standards. Tests are based on a person's weight of 110 kg / 242 lb
 Test EN 16139:2013. Furniture - Strength, durability, stability and safety.

Requirements for non-domestic seating

Foam fire rating CAL117-2013 - pass. BS 5852 Crib5 - on request

Measurements

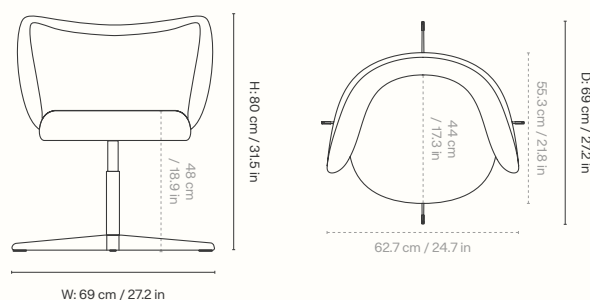

Rico Dining with Castors

The Rico Series welcomes curves and volumes into a classic design defined by soft lines and an embracing expression. Guided by an ever-present sense of contrast, the Rico Dining Chair with Castors juxtaposes the refinement of chrome against the timeless yet comfortable warmth of soft upholstery. This versatile chair features castor wheels for easy mobility and an integrated pump for effortless adjustability.

Customisation Options

Design by Ferm Living

Fabric qualities



To see the specifications of each fabric and available colour assortment please go to the [Fabric and Leather Overview](#)



Rico Dining Chair
with Castors

Information

Manufactured in Italy

Dimensions

Height: 76 - 87.5 cm / 29.9 - 34.3 in

Width: 74 cm / 29.1 in

Depth: 74 cm / 29.1 in

Seat height: 44 - 55.5 cm / 17.3 - 21.9 in

Seat depth: 44 cm / 17.3 in

Weight: 12 kg / 26.5 lb

Materials and construction Backrest: Moulded foam with inner steel structure. Seat: Moulded foam with inner wooden structure. Frame: Polished aluminium. FSC™ Mix-certified wood

Care Please see fermliving.com for care and [maintenance instructions](#)

Packsize 1

Attention This seating is tested to meet relevant strength and durability standards. Tests are based on a person's weight of 110 kg / 242 lb

Test EN 16139:2013. Furniture - Strength, durability, stability and safety.

Requirements for non-domestic seating

Foam fire rating CAL117-2013 - pass. BS 5852 Crib5 - on request

Measurements

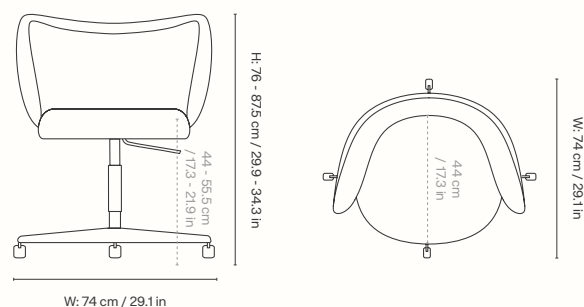

Rico Lounge Chair

The Rico Series welcomes curves and volumes into a classic design defined by soft lines and an embracing expression. The curvaceous nature of the series adds a modern union of comfort and elegance to any room and makes you feel drawn into its motherly embrace.

Customisation Options

Design by Ferm Living

Fabric qualities

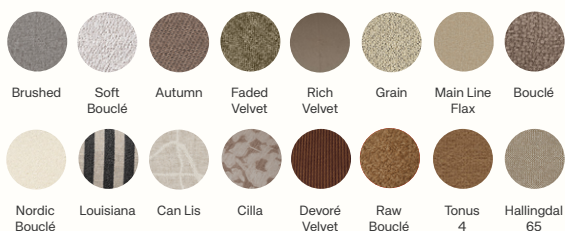

Leather quality



Sheep-skin

To see the specifications of each fabric and available colour assortment please go to the [Fabric and Leather Overview](#)



Rico Lounge Chair

Information

Manufactured in Italy and Lithuania

Dimensions

Height: 76.5 cm / 30.1 in

Width: 87 cm / 34.3 in

Depth: 76 cm / 29.9 in

Back height: 72 cm / 28.3 in

Seat height: 41 cm / 16 in

Seat depth: 55 cm / 21.7 in

Weight: 33 kg / 72.7 lb

Materials and construction Backrest: Moulded foam with inner iron structure. Seat: PU foam with inner wooden structure. Feet: Low density polyethylene. FSC™ Mix-certified wood

Care Please see fermliving.com for care and [maintenance instructions](#)

Packsize 1

Attention This seating is tested to meet relevant strength and durability standards. Tests are based on a person's weight of 110 kg / 242 lb

Test EN 16139:2013. Furniture - Strength, durability, stability and safety. Requirements for non-domestic seating

Foam fire rating CAL117-2013 - pass. BS 5852 Crib5 - on request

Measurements

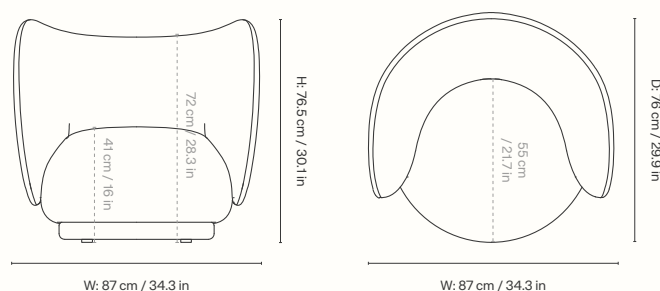

Rico Lounge Chair Piccolo

The Rico Piccolo Lounge Chair offers a compact take on the classic Rico Series. With its soft curves and embracing form, it brings the same sense of comfort and character in a smaller footprint. Ideal for bedrooms, reading nooks or modest living spaces, the chair features a moulded foam backrest supported by an FSC™ Mix-certified wooden structure. Designed to feel both sculptural and inviting, the Piccolo edition is perfect where space is limited but style is not.

Customisation Options

Design by Ferm Living

Fabric qualities

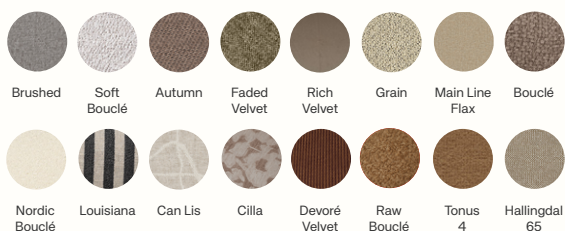

Leather quality



Sheep-skin

To see the specifications of each fabric and available colour assortment please go to the [Fabric and Leather Overview](#)



Rico Lounge Chair Piccolo

Information

Manufactured in Italy
Registered design

Dimensions

Height: 72 cm / 28.3 in
Width: 64 cm / 25.2 in
Depth: 77 cm / 30.3 in
Seat height: 41 cm / 16.1 in
Seat depth: 54 cm / 21.3 in
Weight: 25 kg / 55 lb

Materials and construction Backrest: Moulded foam with inner steel structure.
Seat: PU foam with inner wooden structure. Feet: Low density polyethylene.
FSC™ Mix-certified wood

Care Please see fermliving.com for care and [maintenance instructions](#)

Packsize 1

Attention This seating is tested to meet relevant strength and durability standards. Tests are based on a person's weight of 110 kg / 242 lb

Test EN 16139:2013. Furniture - Strength, durability, stability and safety. Requirements for non-domestic seating

Foam fire rating CAL117-2013 - pass. BS 5852 Crib5 - on request

Measurements

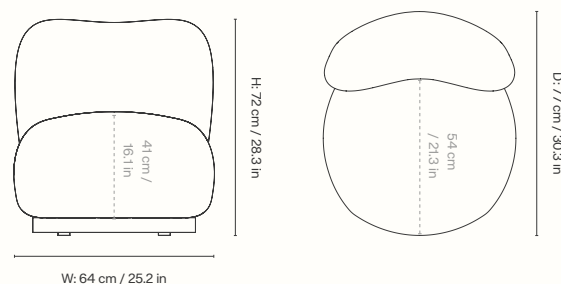

Rico Sofa 2-seater

The Rico Series welcomes curves and volumes into a classic design defined by soft lines and an embracing expression. The curvaceous nature of this petite two-seater adds a modern union of comfort and elegance to any room and makes you feel drawn into its motherly embrace.

Customisation Options

Design by Ferm Living

Fabric qualities

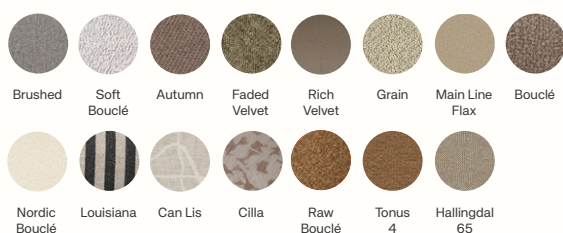

To see the specifications of each fabric and available colour assortment please go to the [Fabric and Leather Overview](#)



Rico Sofa 2-Seater

Information

Manufactured in Italy and Lithuania

Dimensions

Height: 76.5 cm / 30.1 in

Width: 148 cm / 58.3 in

Depth: 84 cm / 33.1 in

Back height: 72 cm / 28.3 in

Seat height: 41 cm / 16 in

Seat depth: 61 cm / 24 in

Weight: 48.5 kg / 106.9 lb

Materials and construction Backrest: Moulded foam with inner iron structure.

Seat: PU foam with inner wooden structure. Feet: Low density polyethylene.

FSC™ Mix-certified wood

Care Please see fermliving.com for care and [maintenance instructions](#)

Packsize 1

Attention This seating is tested to meet relevant strength and durability standards. Tests are based on a person's weight of 110 kg / 242 lb

Test EN 16139:2013. Furniture - Strength, durability, stability and safety.

Requirements for non-domestic seating

Foam fire rating CAL117-2013 - pass. BS 5852 Crib5 - on request

Measurements

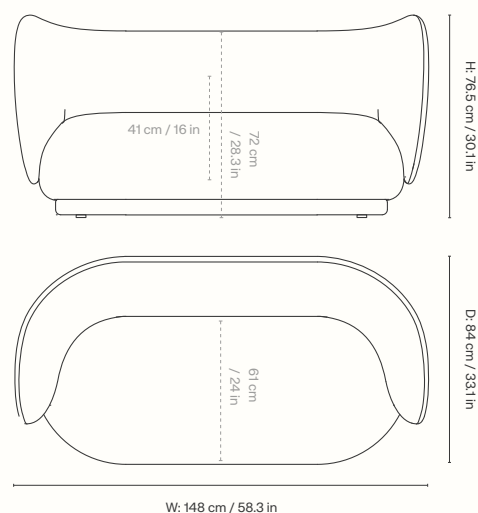

Rico Sofa 3-seater

The Rico Series welcomes curves and volumes into a classic design defined by soft lines and an embracing expression. The curvaceous nature of this three-seater adds a modern union of comfort and elegance to any room and makes you feel drawn into its motherly embrace.

Customisation Options

Design by Ferm Living

Fabric qualities

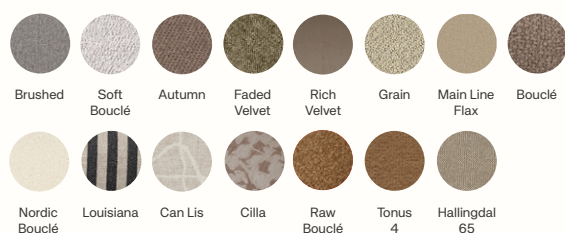

To see the specifications of each fabric and available colour assortment please go to the [Fabric and Leather Overview](#)



Rico Sofa 3-Seater

Information

Manufactured in Italy and Lithuania

Dimensions

Height: 76.5 cm / 30.1 in

Width: 210 cm / 82.7 in

Depth: 84 cm / 33.1 in

Back height: 72 cm / 28.3 in

Seat height: 41 cm / 16 in

Seat depth: 61 cm / 24 in

Weight: 68 kg / 149.9 lb

Materials and construction Backrest: Moulded foam with inner iron structure.

Seat: PU foam with inner wooden structure. Feet: Low density polyethylene.

FSC™ Mix-certified wood

Care Please see fermliving.com for care and [maintenance instructions](#)

Packsize 1

Attention This seating is tested to meet relevant strength and durability standards. Tests are based on a person's weight of 110 kg / 242 lb

Test EN 16139:2013. Furniture - Strength, durability, stability and safety.

Requirements for non-domestic seating

Foam fire rating CAL117-2013 - pass. BS 5852 Crib5 - on request

Measurements

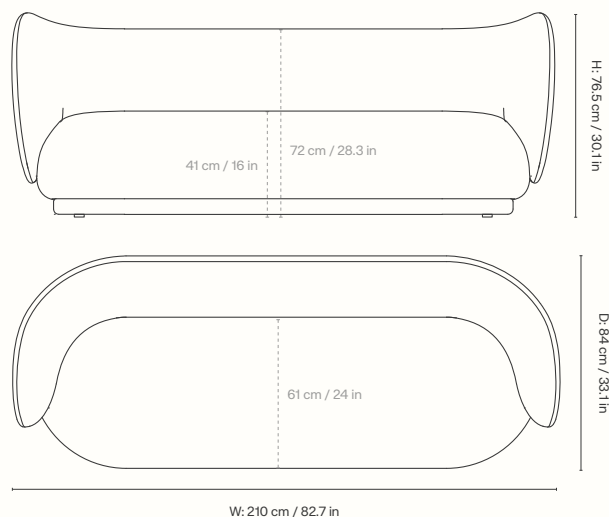

Rico Sofa 4-seater

The Rico Series welcomes curves and volumes into a classic design defined by soft lines and an embracing expression. The curvaceous nature of this four-seater adds a modern union of comfort and elegance to any room and makes you feel drawn into its motherly embrace.

Customisation Options

Design by Ferm Living

Fabric qualities

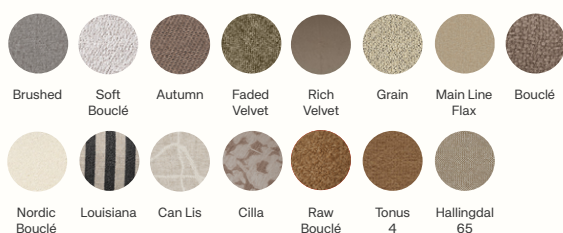

To see the specifications of each fabric and available colour assortment please go to the [Fabric and Leather Overview](#)



Rico Sofa 4-Seater

Information

Manufactured in Italy and Lithuania

Dimensions

Height: 76.5 cm / 30.1 in

Width: 260 cm / 102.4 in

Depth: 84 cm / 33.1 in

Back height: 72 cm / 28.3 in

Seat height: 41 cm / 16 in

Seat depth: 61 cm / 24 in

Weight: 74.5 kg / 164.2 lb

Materials and construction Backrest: Moulded foam with inner iron structure.

Seat: PU foam with inner wooden structure. Feet: Low density polyethylene.

FSC™ Mix-certified wood

Care Please see fermliving.com for care and [maintenance instructions](#)

Packsize 1

Attention This seating is tested to meet relevant strength and durability

standards. Tests are based on a person's weight of 110 kg / 242 lb

Test EN 16139:2013. Furniture - Strength, durability, stability and safety.

Requirements for non-domestic seating

Foam fire rating CAL117-2013 - pass. BS 5852 Crib5 - on request

Measurements

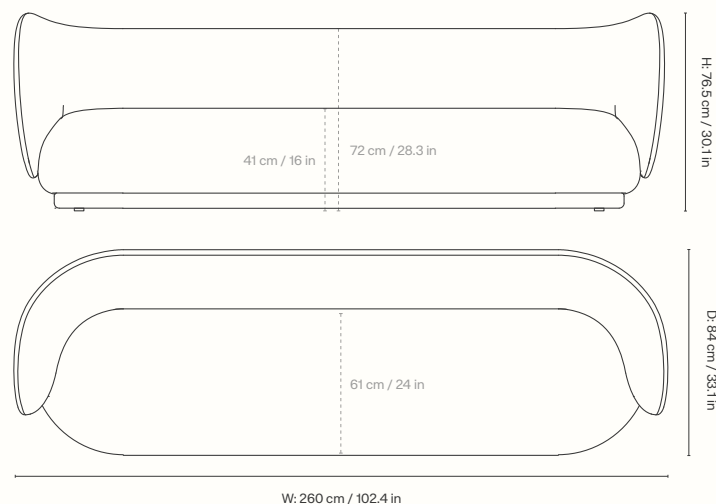

Rico Sofa Curve

The Rico Series welcomes curves and volumes into a classic design defined by soft lines and an embracing expression. The Rico Curve represents a harmonious blend of a chaise longue and a love seat, featuring captivating curves that bring a contemporary fusion of comfort and elegance to any space.

Customisation Options

Design by Ferm Living

Fabric qualities



To see the specifications of each fabric and available colour assortment please go to the [Fabric and Leather Overview](#)



Rico Sofa Curve - Right

Information

Manufactured in Italy

Rico Sofa Curve is available with the seat orientated to the right or left side

Dimensions

Height: 76.5 cm / 30.1 in

Width: 148 cm / 58.3 in

Back height: 72 cm / 28.3 in

Depth: 111.5 cm / 43.9 in

Seat height: 41 cm / 16.1 in

Seat depth: 60-86.5 cm / 23.6-34.1 in

Weight: 43.5 kg / 95.9 lb

Materials and construction Backrest: Moulded foam with inner iron structure.

Seat: PU foam with inner wooden structure. Feet: Low density polyethylene.

FSC™ Mix-certified wood

Care Please see fermliving.com for care and [maintenance instructions](#)

Packsize 1

Attention This seating is tested to meet relevant strength and durability standards. Tests are based on a person's weight of 110 kg / 242 lb

Test EN 16139:2013. Furniture - Strength, durability, stability and safety.

Requirements for non-domestic seating

Foam fire rating CAL117-2013 - pass. BS 5852 Crib5 - on request

Measurements

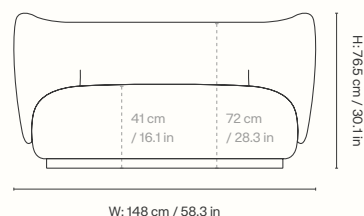

W: 148 cm / 58.3 in

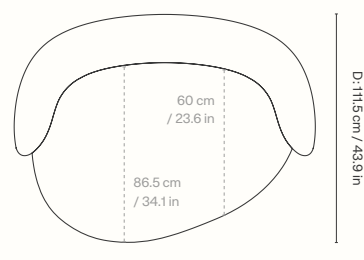

W: 148 cm / 58.3 in

Rico Lounger Sofa

The Rico Series welcomes curves and volumes into a classic design defined by soft lines and an embracing expression. The Rico Lounger Sofa boasts a generously oversized seat that offers ample space for lounging or reclining, effortlessly accommodating your entire family. The sofa's expansive depth and generous proportions make it perfect for relaxing and reading. Crafted with a low-slung expression, it fosters a relaxed, sophisticated ambience, encouraging effortless unwinding and casual comfort.

Customisation Options

Design by Ferm Living

Fabric qualities



To see the specifications of each fabric and available colour assortment please go to the [Fabric and Leather Overview](#)



Rico Lounger Sofa

Information

Manufactured in Italy

Dimensions

Height: 75 cm / 29.5 in
 Width: 210 cm / 82.7 in
 Depth: 105 cm / 41.3 in
 Seat height: 36 cm / 14.2 in
 Seat depth: 81 cm / 31.9 in
 Weight: 67 kg / 147.4 lb

Materials and construction Backrest: Moulded foam with inner iron structure. Seat: PU foam with inner wooden structure. Feet: Low density polyethylene. FSC™ Mix-certified wood

Care Please see fermliving.com for care and [maintenance instructions](#)

Packsize 1

Attention This seating is tested to meet relevant strength and durability standards. Tests are based on a person's weight of 110 kg / 242 lb
 Test EN 16139:2013. Furniture - Strength, durability, stability and safety.

Requirements for non-domestic seating

Foam fire rating CAL117-2013 - pass. BS 5852 Crib5 - on request

Measurements

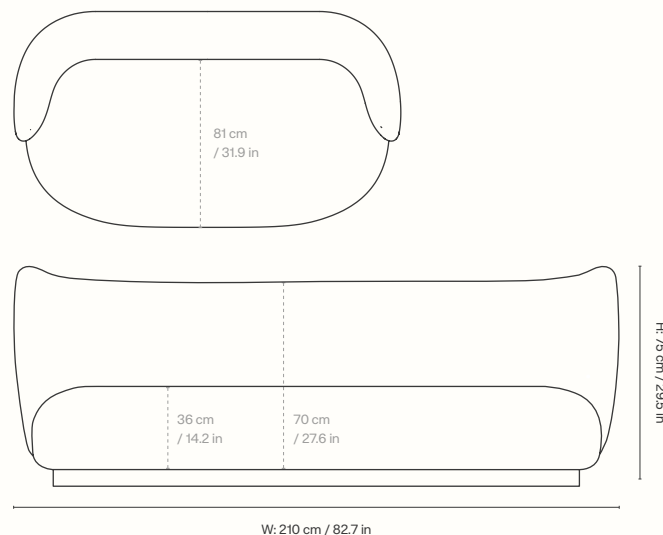

Rico Divan

The Rico Series welcomes curves and volumes into a classic design defined by soft lines and an embracing expression. The Divan is a piece of furniture all its own. It could pass as a daybed, bears a resemblance to a settee, and gives off chaise lounge vibes. Upholstered in a beautifully faded velvet, the soft yet hard-wearing fabric has an enticing, subtle sheen. The curvaceous nature of the series adds a modern union of comfort and elegance to any room and makes you feel drawn into its motherly embrace.

Customisation Options

Design by Ferm Living

Fabric qualities

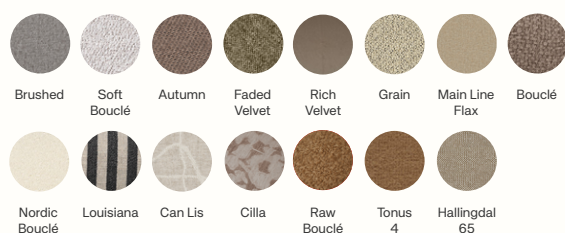

To see the specifications of each fabric and available colour assortment please go to the [Fabric and Leather Overview](#)



Rico Divan - Left

Information

Manufactured in Italy and Lithuania
Backrest on the left or right side

Dimensions

Height: 76.5 cm / 30.1 in
Width: 203 cm / 79.9 in
Back height: 72 cm / 28.3 in
Depth: 84 cm / 33.1 in
Seat height: 41 cm / 16 in
Seat depth: 61 cm / 24 in
Weight: 62 kg / 136.7 lb

Materials and construction Backrest: Moulded foam with inner iron structure.
Seat: PU foam with inner wooden structure. Feet: Low density polyethylene.
FSC™ Mix-certified wood

Care Please see [fermliving.com](#) for care and [maintenance instructions](#)

Packsize 1

Attention This seating is tested to meet relevant strength and durability standards. Tests are based on a person's weight of 110 kg / 242 lb
Test EN 16139:2013. Furniture - Strength, durability, stability and safety.
Requirements for non-domestic seating
Foam fire rating CAL117-2013 - pass. BS 5852 Crib5 - on request

Measurements

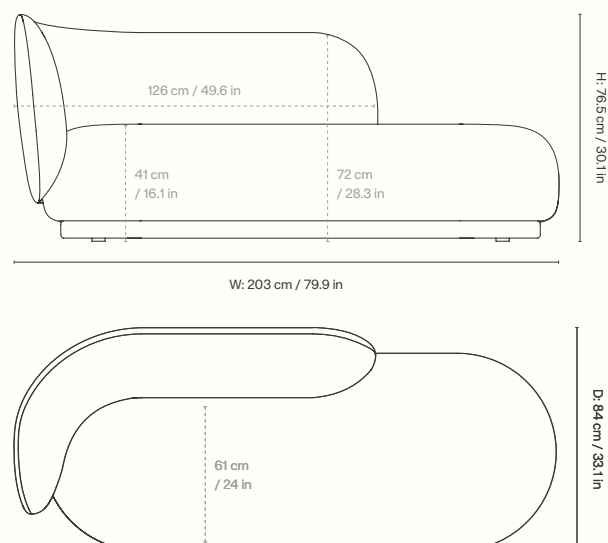

Rico Sofa - Center Module

The Rico Sofa is available as a modular system, offering the freedom to create a layout that suits your space. Combine modules to form a corner sofa, an extended seat or a standalone piece. Each element retains the signature curvy silhouette of the Rico Series, while the deeper seat provides added comfort and a more generous feel. Crafted with an FSC™ Mix-certified wooden structure, the modular design offers versatility for both private homes and larger public interiors such as hotel lobbies or lounge areas.

Customisation Options

Design by Ferm Living

Fabric qualities



To see the specifications of each fabric and available colour assortment please go to the [Fabric and Leather Overview](#)



Rico Sofa - Center Module

Information

Provided with connection system to link modules together
Comes with adjustable feet
Manufactured in Italy

Dimensions

Height: 72 cm / 28.3 in
Width: 81 cm / 31.9 in
Depth: 94 cm / 37 in
Seat height: 41 cm / 16.1 in
Seat depth: 70 cm / 27.6 in
Weight: 34 kg / 75 lb

Materials and construction Backrest/seat: PU foam with inner wooden structure. Feet: Low density polyethylene. FSC™ Mix-certified wood
Care Please see [fermliving.com](#) for care and [maintenance instructions](#)
Packsize 1

Attention This seating is tested to meet relevant strength and durability standards. Tests are based on a person's weight of 110 kg / 242 lb
Test EN 16139:2013. Furniture - Strength, durability, stability and safety. Requirements for non-domestic seating
Foam fire rating CAL117-2013 - pass. BS 5852 Crib5 - on request

Measurements

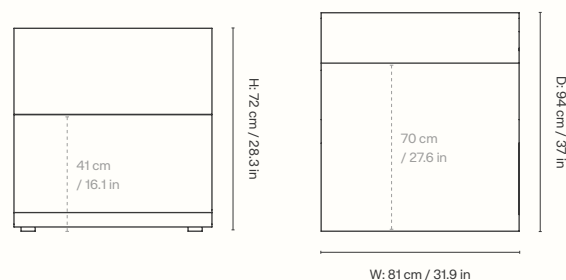

Rico Sofa - Armrest End Module

The Rico Sofa is available as a modular system, offering the freedom to create a layout that suits your space. Combine modules to form a corner sofa, an extended seat or a standalone piece. Each element retains the signature curvy silhouette of the Rico Series, while the deeper seat provides added comfort and a more generous feel. Crafted with an FSC™ Mix-certified wooden structure, the modular design offers versatility for both private homes and larger public interiors such as hotel lobbies or lounge areas.

Customisation Options

Design by Ferm Living

Fabric qualities



To see the specifications of each fabric and available colour assortment please go to the [Fabric and Leather Overview](#)

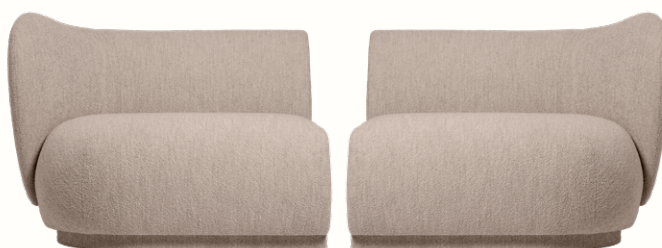

Rico Sofa - Armrest Left

Rico Sofa - Armrest Right

Information

Provided with connection system to link modules together
Comes with adjustable feet
Manufactured in Italy

Dimensions

Height: 76.5 cm / 30.1 in
Width: 101 cm / 39.8 in
Depth: 94 cm / 37 in
Back height: 72 cm / 28.3 in
Seat height: 41 cm / 16.1 in
Seat depth: 70 cm / 27.6 in
Weight: 36 kg / 79.4 lb

Materials and construction Backrest/seat: PU foam with inner wooden structure. Feet: Low density polyethylene. FSC™ Mix-certified wood
Care Please see [fermliving.com](#) for care and [maintenance instructions](#)
Packsize 1

Attention This seating is tested to meet relevant strength and durability standards. Tests are based on a person's weight of 110 kg / 242 lb
Test EN 16139:2013. Furniture - Strength, durability, stability and safety. Requirements for non-domestic seating
Foam fire rating CAL117-2013 - pass. BS 5852 Crib5 - on request

Measurements

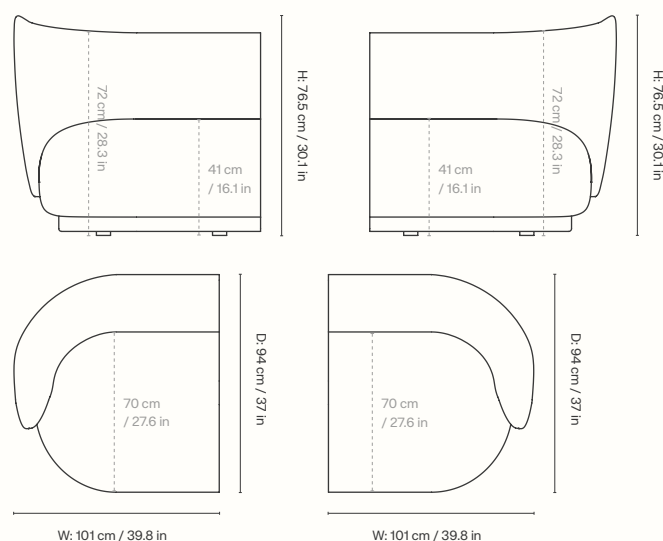

Rico Sofa - Open End Module

The Rico Sofa is available as a modular system, offering the freedom to create a layout that suits your space. Combine modules to form a corner sofa, an extended seat or a standalone piece. Each element retains the signature curvy silhouette of the Rico Series, while the deeper seat provides added comfort and a more generous feel. Crafted with an FSC™ Mix-certified wooden structure, the modular design offers versatility for both private homes and larger public interiors such as hotel lobbies or lounge areas.

Customisation Options

Design by Ferm Living

Fabric qualities



To see the specifications of each fabric and available colour assortment please go to the [Fabric and Leather Overview](#)



Rico Sofa - Open End Left

Rico Sofa - Open End Right

Information

Provided with connection system to link modules together
Comes with adjustable feet
Manufactured in Italy

Dimensions

Height: 72 cm / 28.3 in
Width: 91 cm / 35.8 in
Depth: 94 cm / 37 in
Seat height: 41 cm / 16.1 in
Seat depth: 70 cm / 27.6 in
Weight: 29 kg / 63.9 lb

Materials and construction Backrest/seat: PU foam with inner wooden structure. Feet: Low density polyethylene. FSC™ Mix-certified wood
Care Please see [fermliving.com](#) for care and [maintenance instructions](#)
Packsize 1

Attention This seating is tested to meet relevant strength and durability standards. Tests are based on a person's weight of 110 kg / 242 lb
Test EN 16139:2013. Furniture - Strength, durability, stability and safety. Requirements for non-domestic seating
Foam fire rating CAL117-2013 - pass. BS 5852 Crib5 - on request

Measurements

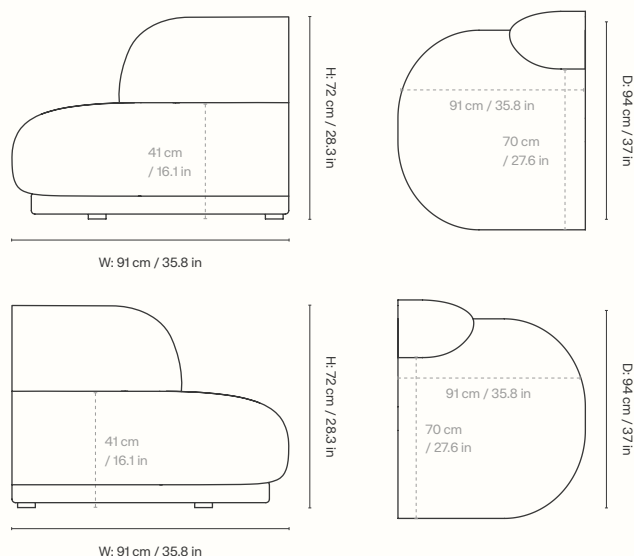

Rico Sofa - Corner 45 Degrees

The Rico Sofa is available as a modular system, offering the freedom to create a layout that suits your space. Combine modules to form a corner sofa, an extended seat or a standalone piece. Each element retains the signature curvy silhouette of the Rico Series, while the deeper seat provides added comfort and a more generous feel. Crafted with an FSC™ Mix-certified wooden structure, the modular design offers versatility for both private homes and larger public interiors such as hotel lobbies or lounge areas.

Customisation Options

Design by Ferm Living

Fabric qualities



To see the specifications of each fabric and available colour assortment please go to the [Fabric and Leather Overview](#)



Rico Sofa - Corner 45 Degrees

Information

Provided with connection system to link modules together
Comes with adjustable feet
Manufactured in Italy

Dimensions

Height: 72 cm / 28.3 in
Width: 93 cm / 35.6 in
Depth: 106 cm / 41.7 in
Seat height: 41 cm / 16.1 in
Seat depth: 70 cm / 27.6 in
Weight: 25 kg / 55.1 lb

Materials and construction Backrest/seat: PU foam with inner wooden structure. Feet: Low density polyethylene. FSC™ Mix-certified wood
Care Please see [fermliving.com](#) for care and [maintenance instructions](#)
Packsize 1

Attention This seating is tested to meet relevant strength and durability standards. Tests are based on a person's weight of 110 kg / 242 lb
Test EN 16139:2013. Furniture - Strength, durability, stability and safety. Requirements for non-domestic seating
Foam fire rating CAL117-2013 - pass. BS 5852 Crib5 - on request

Measurements

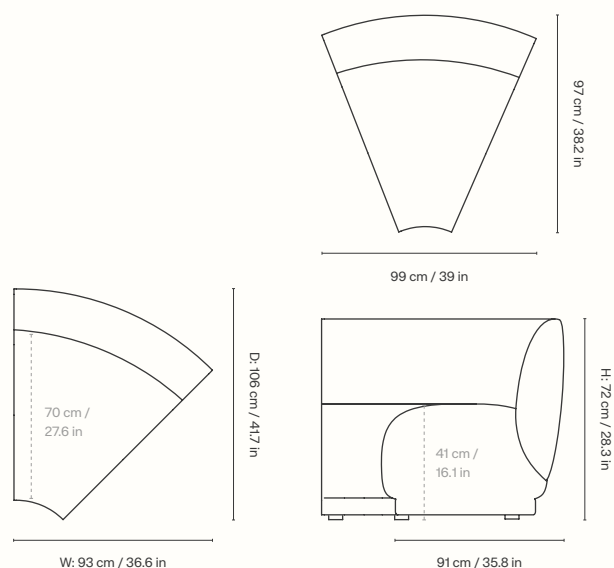

Rico Sofa - Corner 90 Degrees

The Rico Sofa is available as a modular system, offering the freedom to create a layout that suits your space. Combine modules to form a corner sofa, an extended seat or a standalone piece. Each element retains the signature curvy silhouette of the Rico Series, while the deeper seat provides added comfort and a more generous feel. Crafted with an FSC™ Mix-certified wooden structure, the modular design offers versatility for both private homes and larger public interiors such as hotel lobbies or lounge areas.

Customisation Options

Design by Ferm Living

Fabric qualities



To see the specifications of each fabric and available colour assortment please go to the [Fabric and Leather Overview](#)

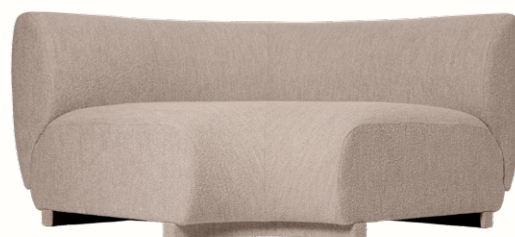

Rico Sofa - Corner 90 Degrees

Information

Provided with connection system to link modules together
Comes with adjustable feet
Manufactured in Italy

Dimensions

Height: 72 cm / 28.3 in
Width: 125 cm / 49.2 in
Depth: 125 cm / 49.2 in
Seat height: 41 cm / 16.1 in
Seat depth center: 86 cm / 33.9 in
Seat depth sides: 70 cm / 27.6 in
Weight: 46 kg / 101.4 lb

Materials and construction Backrest/seat: PU foam with inner wooden structure. Feet: Low density polyethylene. FSC™ Mix-certified wood

Care Please see [fermliving.com](#) for care and [maintenance instructions](#)

Packsize 1

Attention This seating is tested to meet relevant strength and durability standards. Tests are based on a person's weight of 110 kg / 242 lb
Test EN 16139:2013. Furniture - Strength, durability, stability and safety. Requirements for non-domestic seating
Foam fire rating CAL117-2013 - pass. BS 5852 Crib5 - on request

Measurements

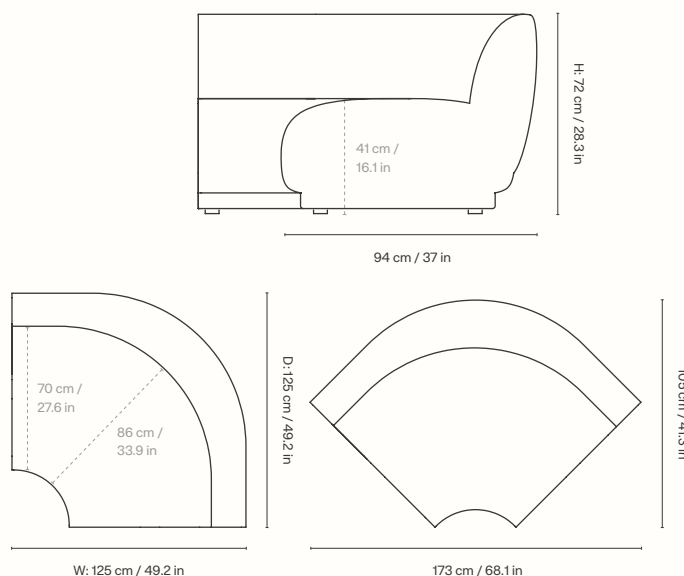

Rico Lounger Pouf

Enhance your living space with the Rico Lounger Pouf, meticulously crafted to harmonise with the Rico Lounger Sofa. Mirroring its curvaceous proportions, the pouf features an organic, elongated shape that frames a visually captivating silhouette. This pouf is incredibly versatile and can be used in various ways to enhance your living space, whether used as a standalone seating option, a footrest paired with the Rico Lounger Sofa, or even as an impromptu coffee table with the addition of a tray.

Customisation Options

Design by Ferm Living

Fabric qualities

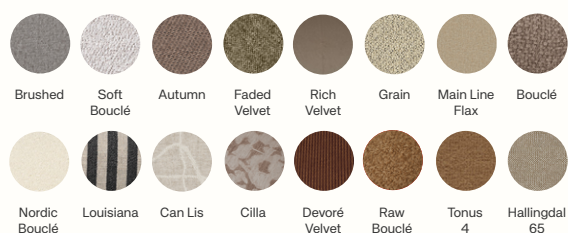

To see the specifications of each fabric and available colour assortment please go to the [Fabric and Leather Overview](#)



Rico Lounger Pouf

Information

Manufactured in Italy

Dimensions

Height: 36 cm / 14.2 in
 Width: 86 cm / 33.9 in
 Depth: 62 cm / 24.4 in
 Weight: 12 kg / 26.5 lb

Materials and construction Backrest/seat: PU foam with inner wooden structure. Feet: Low density polyethylene. FSC™ Mix-certified wood
Care Please see [fermliving.com](#) for care and [maintenance instructions](#)
Packsize 1

Attention This seating is tested to meet relevant strength and durability standards. Tests are based on a person's weight of 110 kg / 242 lb
Test EN 16139:2013. Furniture - Strength, durability, stability and safety. Requirements for non-domestic seating

Foam fire rating CAL117-2013 - pass. BS 5852 Crib5 - on request

Measurements

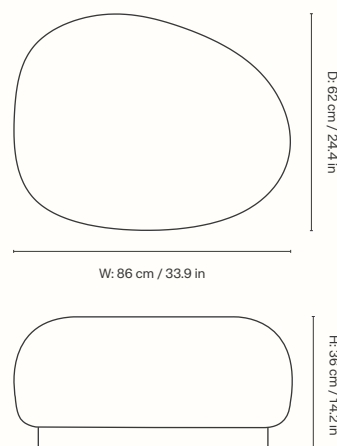

Rico Pouf

The Rico Series welcomes curves and volumes into a classic design defined by soft lines and an embracing expression. The perfect companion to the Rico Lounge Chair, this pouf is a multipurpose piece of furniture that works as a footrest or an extra seat when you need it. The curvaceous nature of the series adds a modern union of comfort and elegance to any room.

Customisation Options

Design by Ferm Living

Fabric qualities

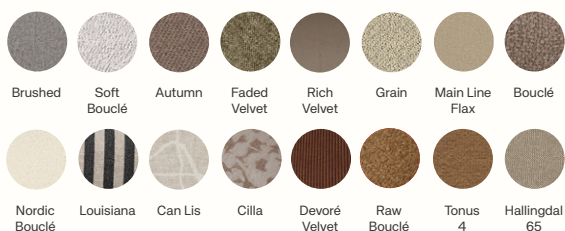

Leather quality



Sheep-skin

To see the specifications of each fabric and available colour assortment please go to the [Fabric and Leather Overview](#)



Rico Pouf

Information

Manufactured in Italy and Lithuania

Dimensions

Height: 41 cm / 16.1 in

Diameter: 60 cm / 23.6 in

Weight: 10 kg / 22 lb

Materials and construction Backrest/seat: PU foam with inner wooden structure. Feet: Low density polyethylene. FSC™ Mix-certified wood

Care Please see fermliving.com for care and [maintenance instructions](#)

Packsize 1

Attention This seating is tested to meet relevant strength and durability standards. Tests are based on a person's weight of 110 kg / 242 lb

Foam fire rating CAL117-2013 - pass. BS 5852 Crib5 - on request

Measurements

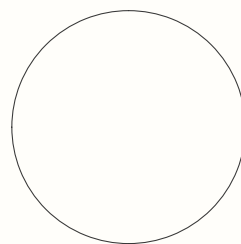

D: 60 cm / 23.6 in

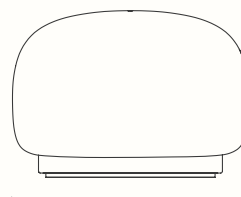

D: 60 cm / 23.6 in

H: 41 cm / 16.1 in

Rico Lounger Ottoman

Enhance your living space with the Rico Lounger Ottoman, meticulously crafted to harmonise with the Rico Lounger Sofa. Mirroring its curvaceous proportions, the ottoman features an organic, elongated shape that frames a visually captivating silhouette. Whether styled alone or paired with other pieces from the collection, it provides endless possibilities for creating dynamic and sculptural seating arrangements.

Customisation Options

Design by Ferm Living

Fabric qualities

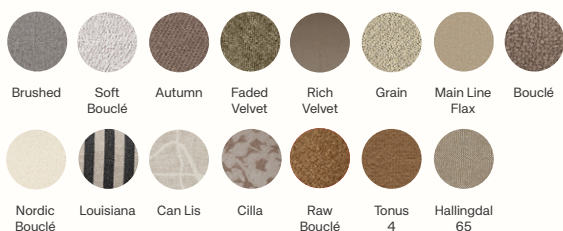

To see the specifications of each fabric and available colour assortment please go to the [Fabric and Leather Overview](#)



Rico Lounger Ottoman

Information

Manufactured in Italy
Registered design

Dimensions

Height: 36 cm / 14.2 in
Width: 147 cm / 57.9 in
Depth: 75 cm / 29.5 in
Weight: 25 kg / 55.1 lb

Materials and construction Backrest/seat: PU foam with inner wooden structure. Feet: Low density polyethylene. FSC™ Mix-certified wood
Care Please see fermliving.com for care and [maintenance instructions](#)
Packsizes 1

Attention This seating is tested to meet relevant strength and durability standards. Tests are based on a person's weight of 110 kg / 242 lb
Foam fire rating CAL117-2013 - pass. BS 5852 Crib5 - on request

Measurements

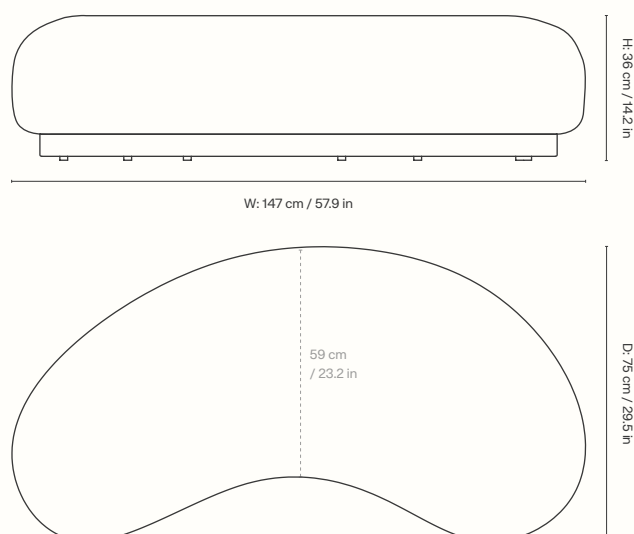

Rico Ottoman

The Rico Series welcomes curves and volumes into a classic design defined by soft lines and an embracing expression. The ottoman is a multipurpose piece of furniture perfect for any ensemble, whether you are in need of a side table, a footrest or a space seat in the living room. The curvaceous nature of the series adds a modern union of comfort and elegance to any room and makes you feel drawn into its motherly embrace.

Customisation Options

Design by Ferm Living

Fabric qualities

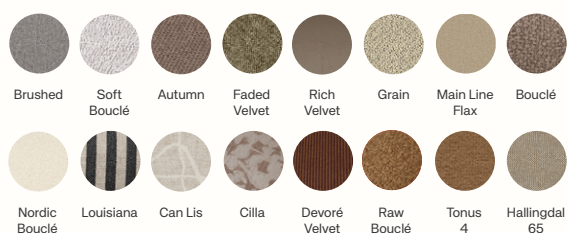

To see the specifications of each fabric and available colour assortment please go to the [Fabric and Leather Overview](#)



Rico Ottoman

Information

Manufactured in Italy
Registered design

Dimensions

Height: 36 cm / 14.2 in
Width: 147 cm / 57.9 in
Depth: 75 cm / 29.5 in
Weight: 25 kg / 55.1 lb

Materials and construction Backrest/seat: PU foam with inner wooden structure. Feet: Low density polyethylene. FSC™ Mix-certified wood
Care Please see fermliving.com for care and [maintenance instructions](#)
Packsizes 1

Attention This seating is tested to meet relevant strength and durability standards. Tests are based on a person's weight of 110 kg / 242 lb
Foam fire rating CAL117-2013 - pass. BS 5852 Crib5 - on request

Measurements

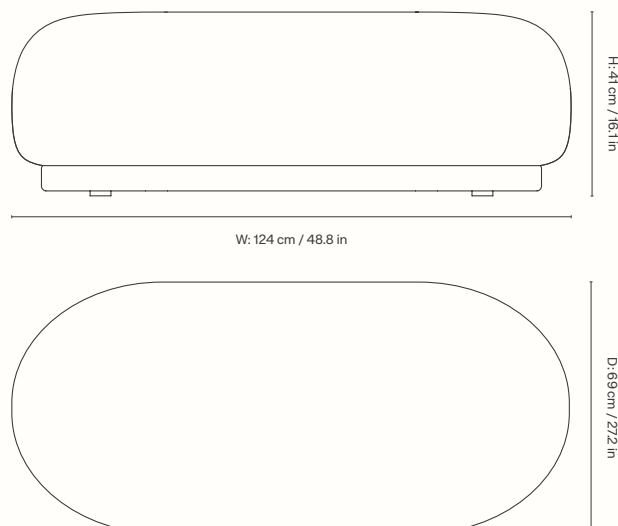

Space to feel comfortably you