

Kona Collection

Product Fact Sheet



FERM
LIVING

Kona Side Table

Made to complement our Kona Bed, the Kona Side Table in FSC™-certified oak veneer peeks out from under the bed frame to provide a practical platform for a book, lamp and glass of water. The Japanese-inspired design is elevated above the ground to the perfect height. But it doesn't have to stay in the bedroom: use it to display objects in a living room or bathroom.



110260210
Natural



1104269071
Dark Stained

Information

Size H: 10 x W: 49 x D: 33.5 cm /

H: 4 x W: 19 x D: 13 in

Material FSC™ Mix-certified oak veneer with chipboard core. Steel with powder coating. Dark stained and lacquered

Care Wipe with a damp cloth

Certificates FSC MIX 70% PBN-COC-071313

Country of origin Latvia

Net. weight 4 kg / 8.82 lb

Packsizes 1

Measurements



The mark of responsible forestry

Kona Low Table

Embrace the art of 'low living' with the Japanese-inspired Kona Low Table. With its simple and elegant construction, the design is elevated just above ground to the perfect height. Use it to display plants, books and your favourite objects or as a coffee table for when you're lounging on cushions or on the floor. The product is FSC™-certified.



1104263937
Natural



1104269084
Dark Stained

Information

Size H: 14 x W: 78 x D: 47.5 /
H: 5 x W: 30 x D: 19 in

Material FSC™ Mix-certified oak veneer with chipboard core. Steel with powder coating. Dark stained and lacquered

Care Wipe with a damp cloth

Certificates FSC MIX 70% PBN-COC-071313

Country of origin Latvia

Net. weight 9,6 kg / 21.16 lb

Packsize 1

Measurements



The mark of responsible forestry

Kona Display Table

Embrace the art of 'low living' with the Japanese-inspired Kona Display Table. Made in FSC™ Mix-certified oak veneer, it has a simple and elegant construction, the design is elevated just above ground to the perfect height. Use it to display plants, books and your favourite objects or as a coffee table for when you are lounging on cushions, or on the floor.



1104264894
Natural



1104268684
Dark Stained

Information

Size H: 20 x W: 138 x D: 34 /
H :8 x W: 54 x D: 13 in

Material FSC™ Mix-certified oak veneer with chipboard core. Steel with powder coating. Dark stained and lacquered

Care Wipe with a damp cloth

Certificates FSC MIX 70% PBN-COC-071313

Country of origin Latvia

Net. weight 20 kg / 44.09 lb

Packsize 1

Measurements

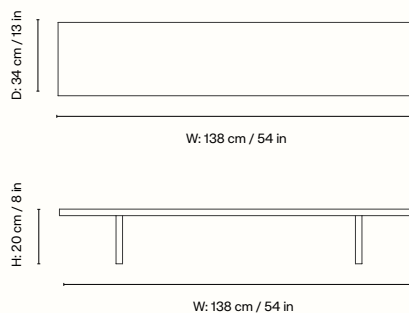

Kona Bench

The Kona Bench offers a blend of functionality and style infused with Japandi aesthetics. Featuring open storage beneath the seating area that's ideal for books in a living room, shoes in an entryway or as an elegant storage addition at the end of a bed.



1104268685
Natural



1104269072
Dark Stained

Information

Size H: 42 x W: 138 x D: 34 /
H: 16 x W: 54 x D: 13 in

Material FSC™ Mix-certified oak veneer with chipboard core. Steel with powder coating. Dark stained and lacquered

Care Wipe with a damp cloth

Product Notes Height and width between shelves:
H: 18.5 x W: 47.8 cm / H: 7,3 x W: 18.8 inc.

Certificates FSC MIX 70% PBN-COC-071313

Country of origin Latvia

Net. weight 28 kg / 61,73 lb

Packsize 1

Measurements

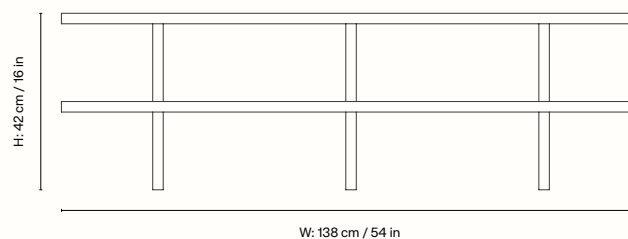
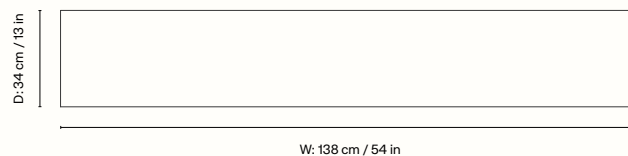

Kona Bookcase 1x4

Expanding the Kona family, the Kona Bookcase offers a blend of functionality and style infused with Japandi aesthetics. The bookcase is crafted from FSC™ Mix-certified oak veneer with an MDP core. Offered in varying dimensions, the bookcase seamlessly fits into living rooms, hallways and bedrooms, providing ample space for books, decor, and keepsakes. Its clean lines and simplistic design create a calming atmosphere, making it a perfect addition to modern and minimalist interiors.



1104270030
Natural



1104270031
Dark Stained

Information

Size H: 141 x W: 75 x D: 30 /

H: 55 x W: 29 x D: 12 in

Material FSC™ Mix-certified oak veneer with chipboard core. Steel with powder coating. Dark stained and lacquered

Care Wipe with a damp cloth. Do not leave the surface wet

Product Notes Height and width of the individual bookcase: H: 32,0 x W: 45 cm / H: 12,6 x W: 17,7 in

Certificates FSC MIX 70% PBN-COC-071313

Country of origin Latvia

Net. weight 31 kg / 68,34 lb

Packsize 1

Measurements

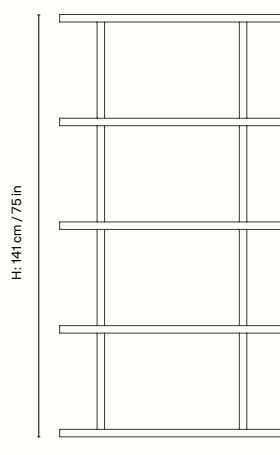

W: 75 cm / 29 in

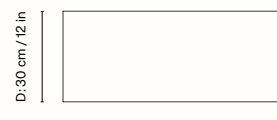

W: 75 cm / 29 in



Kona Bookcase 2X2

Expanding the Kona family, the Kona Bookcase offers a blend of functionality and style infused with Japandi aesthetics. The bookcase is crafted from FSC™ Mix-certified oak veneer with an MDP core. Offered in varying dimensions, the bookcase seamlessly fits into living rooms, hallways and bedrooms, providing ample space for books, decor, and keepsakes. Its clean lines and simplistic design create a calming atmosphere, making it a perfect addition to modern and minimalist interiors.



1104270034
Natural



1104270036
Dark Stained

Information

Size H: 72 x W: 122.5 x D: 30 /
H: 28 x W: 48 x D: 12 in

Material FSC™ Mix-certified oak veneer with chipboard core. Steel with powder coating. Dark stained and lacquered

Care Wipe with a damp cloth. Do not leave the surface wet

Product Notes Height and width of the individual bookcase: H: 32,0 x W: 45 cm / H: 12,6 x W: 17,7 in

Certificates FSC MIX 70% PBN-COC-071313

Country of origin Latvia

Net. weight 28,2 kg / 62.17 lb

Packsizes 1

Measurements

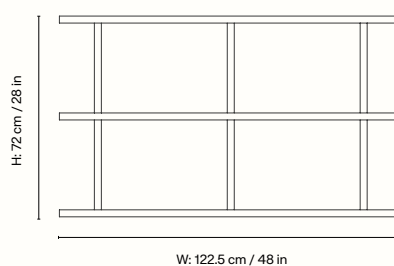
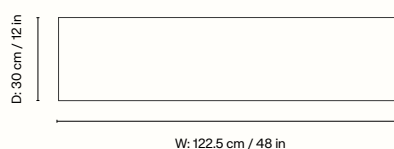

Kona Bookcase 2x4

Expanding the Kona family, the Kona Bookcase offers a blend of functionality and style infused with Japandi aesthetics. The bookcase is crafted from FSC™ Mix-certified oak veneer with an MDP core. Offered in varying dimensions, the bookcase seamlessly fits into living rooms, hallways and bedrooms, providing ample space for books, decor, and keepsakes. Its clean lines and simplistic design create a calming atmosphere, making it a perfect addition to modern and minimalist interiors.



1104270032
Natural



1104270033
Dark Stained

Information

Size H: 141 x W: 122.5 x D: 30 /

H: 55 x W: 48 x D: 12 in

Material FSC™ Mix-certified oak veneer with chipboard core. Steel with powder coating. Dark stained and lacquered

Care Wipe with a damp cloth. Do not leave the surface wet

Product Notes Height and width of the individual bookcase: H: 32,0 x W: 45 cm / H: 12,6 x W: 17,7 in

Certificates FSC MIX 70% PBN-COC-071313

Country of origin Latvia

Net. weight 50.2 kg / 56 lb

Packsize 1



Measurements

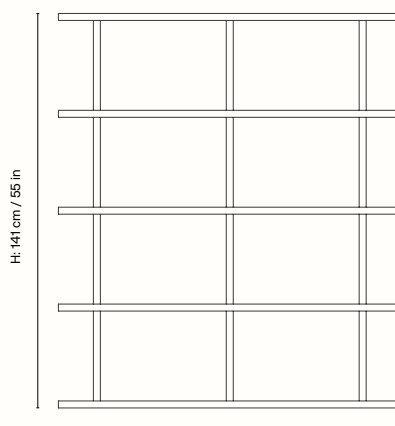

Kona Bookcase 3x2

Expanding the Kona family, the Kona Bookcase offers a blend of functionality and style infused with Japandi aesthetics. The bookcase is crafted from FSC™ Mix-certified oak veneer with an MDP core. Offered in varying dimensions, the bookcase seamlessly fits into living rooms, hallways and bedrooms, providing ample space for books, decor, and keepsakes. Its clean lines and simplistic design create a calming atmosphere, making it a perfect addition to modern and minimalist interiors.



1104270039
Natural



1104270040
Dark Stained

Information

Size H: 72 x W: 170 x D: 30 cm /

H: 28 x W: 66 x D: 12 in

Material FSC™ Mix-certified oak veneer with chipboard core. Steel with powder coating. Dark stained and lacquered

Care Wipe with a damp cloth. Do not leave the surface wet

Product Notes Height and width of the individual bookcase

Certificates FSC MIX 70% PBN-COC-071313

Country of origin Latvia

Net. weight 38.6 kg / 85.1 lb

Packsize 1

Measurements

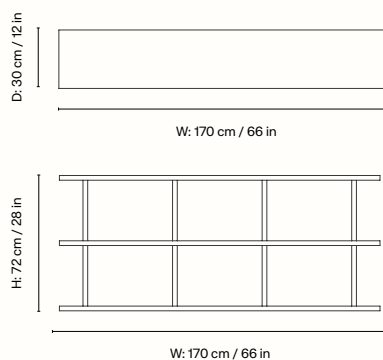

Kona Bookcase - 3x6

The Kona Bookcase expands on the clean lines and quiet functionality of the Kona Family, offering a taller format with generous proportions. Crafted from FSC™ Mix-certified materials, it features three columns and six open shelves, providing ample space for storing books, displaying objects or organising everyday essentials. Its calm, architectural presence makes it well-suited to both home and workspace settings

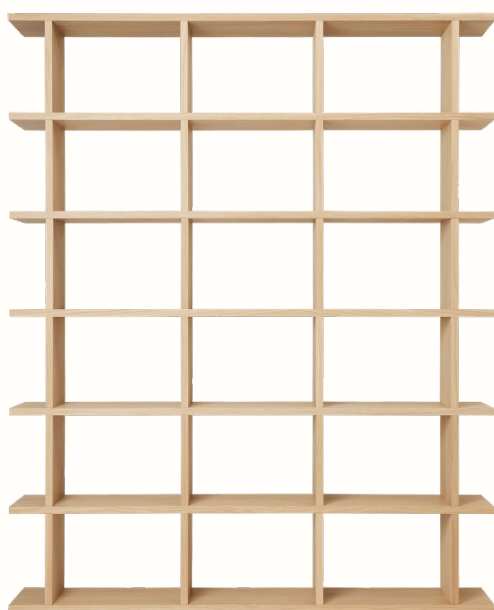

1104272381
Natural

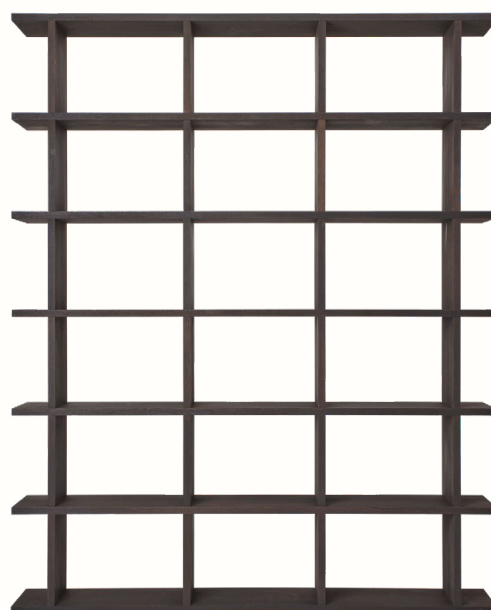

1104272382
Dark Stained

Information

Size H: 210 x W: 170 x D: 30 cm /

H: 82 x W: 66 x D: 12 in

Material FSC™ Mix-certified oak veneer with chipboard core. Steel with powder coating. Dark stained and lacquered

Care Wipe with a damp cloth

Product Notes Height and width of the individual bookcase: H: 32,0 x W: 45 cm / H: 12,6 x W: 17,7 in

Certificates FSC MIX 70% PBN-COC-071313

Country of origin Latvia

Net. weight 110 kg / 242.51 lb

Packsize 1

Measurements

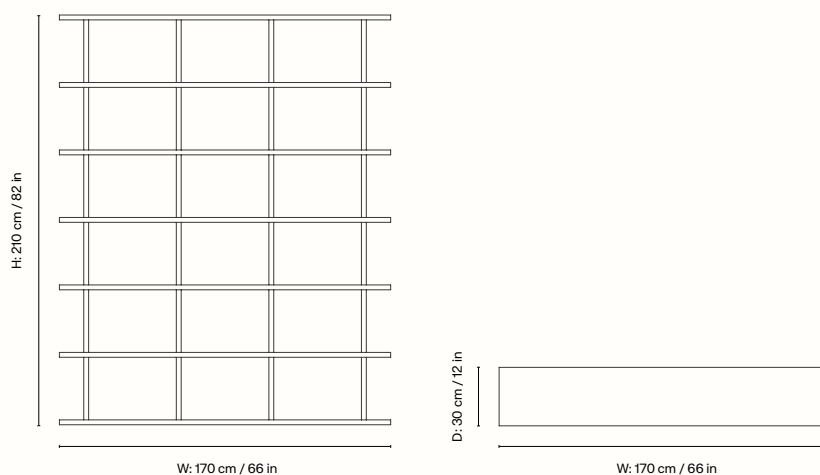

Kona Bookcase Cabinet Insert

The Cabinet Insert adds functional closed storage to the Kona Bookcase while maintaining its clean expression. Made from FSC™ Mix-certified materials, it features a push-to-open mechanism and doors that can be mounted to open from the front or back, left or right, to suit your space. Multiple inserts can be configured during assembly to create a personalised storage setup. Please note the Kona Bookcase Cabinet Insert must be built into the structure and cannot be added after assembly.



1104272371
Natural



1104272370
Dark Stained

Information

Size H: 32 x W: 50 x D: 30 cm /

H: 12 x W: 20 x D: 12 in

Material FSC™ Mix-certified oak veneer with chipboard core. Steel with powder coating. Dark stained and lacquered

Care Wipe with a damp cloth

Product Notes The bookcase features a push-to-open mechanism for easy access without handles

Certificates FSC MIX 70% PBN-COC-071313

Country of origin Latvia

Net. weight 6 kg / 13.23 lb

Packsize 1

Measurements

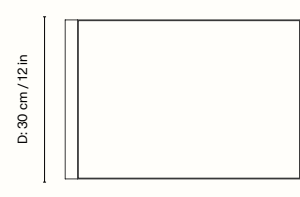
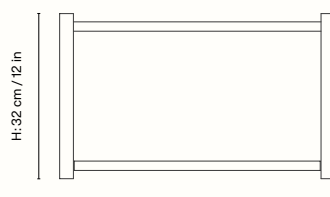

Kona Daybed

Inspired by traditional Japanese furniture and 'low living', our Kona Daybed is ideal for lounging and reading. With a name derived from the Japanese word for 'corner,' the daybed is made from sturdy oak veneer and features a low headboard and raised back panel. Made to complement the Kona Daybed, the Kona Side Table in oak veneer peeks out from under the bed frame to provide a practical platform for a book, lamp and glass of water. This product is FSC™-certified. Fits the Kona Mattress



110259210
Natural



1104269077
Dark Stained

Information

Size H: 65 x W: 207 x D: 97 cm /

H: 25 x W: 81 x D: 38 in

Material FSC™ Mix-certified oak veneer with chipboard core. Steel with powder coating. Dark stained and lacquered

Care Wipe with a damp cloth

Product Notes Can be mounted in left or right configuration. Fits mattress 90 x 200 cm / 35.4 x 78.6 in. Registered design

Certificates FSC MIX 70% PBN-COC-071313

Country of origin Latvia

Net. weight 71.6 kg / 158.73 lb

Packsize 1

Measurements



Kona Mattress

Transform the Kona Daybed into a cosy nook for lounging and reading with this tailor-made extension of the beloved Kona Mattress. Expertly crafted from soft bouclé fabric, this mattress is designed to fit the Kona Daybed frame perfectly. Providing exceptional comfort, the tactile surface of the bouclé adds a unique sensory experience that effortlessly enhances any space. Fits the Kona Daybed



1104269998
Soft Bouclé - Natural



1104263414
Pasadena - Sand/Black

Information

Size H: 9.5 x W: 202 x D: 92 cm /

H: 4 x W: 79 x D: 36 in

Material Fabric: Pasadena: 34% Linen, 27% Viscose, 17% Polyester, 12% Cotton, 8% Wool and 2% other fibers. Inside: Foam

Care Remove wet stains by carefully dabbing with a lint-free cloth or sponge wrung in warm detergent-free water. Professional dry cleaning for heavier stains

Product Notes Fits the Kona Daybed

Country of origin Italy

Net. weight 4.5 kg / 9.92 lb

Packsizes 1

Measurements

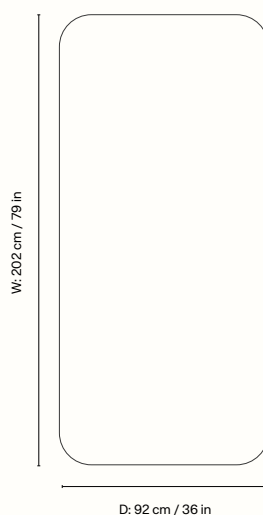

Space to feel comfortably you